

John Deere Sprayer Parts Guide

Australia and New Zealand, July 2023



JOHN DEERE







Contents

<u>Spray Nozzles</u>	1
<u>Selecting the Right Spray Nozzle</u>	2
<u>John Deere Label Information</u>	6
<u>Primary Nozzles</u>	7
<u>High-flow (HF)</u>	9
<u>Ultra-low-drift (ULD)</u>	13
<u>3D</u>	20
<u>Low-drift Max (LDM)</u>	27
<u>Low-drift Twin (LDT)</u>	31
<u>Ultra-low-drift Max (ULDM)</u>	35
<u>Primary Nozzles Index</u>	39
<u>Secondary Nozzles</u>	40
<u>Straight Stream Ceramic (STC)</u>	41
<u>GuardianAir Twin™ (GAT)</u>	48
<u>Low-Drift Air (LDA)</u>	55
<u>Guardian™ (LDX)</u>	62
<u>Extended Range (ER)</u>	69
<u>Low Drift (LD)</u>	76
<u>Flood (FL), Disc (D)</u>	80
<u>Hollow Cone Spray - Disc & Cores</u>	81
<u>Even Spray (ES)</u>	82
<u>Boomless Flat Fan Nozzles (XT)</u>	83
<u>Caps, Adapters and Nozzle Bodies</u>	84
<u>Pumps</u>	90
<u>Upgrades and Accessories</u>	91
<u>Technical Information</u>	98



SPRAY NOZZLES

Broadcast Nozzles

- Herbicides, insecticides and fungicide applications
- Tapered fan pattern designed for spray overlap and uniform coverage

Broadcast Wide-Angle Nozzles

- Fertilisers and specialty applications
- Wide spray pattern overlaps adjacent patterns for uniform coverage at lower boom heights

Streaming Nozzles

- Fertiliser applications
- Straight streams minimize foliar contact while providing uniform soil distribution of liquid fertilizers

Banding and Directed Nozzles

- Used for targeted spraying or between crop rows for no spray pattern overlap
- Used for in-furrow fertilizers and pesticides

Specialty Nozzles

- Boomless, specialty crop, turf, acid-resistant, misting and more

Read the product label thoroughly and look for information on droplet size, application rate, spray quality and environmental restrictions.

Selecting the Right Sprayer Nozzle

Download the John Deere EquipmentPlus App to select and buy nozzles for all your application needs.

Spray nozzles are often the smallest and most overlooked piece of equipment on a machine. However, they have the greatest effect on the accuracy and efficiency of each application. John Deere offers spray nozzles for a variety of pressure ranges, flow rates and spray patterns to fit any spray application.

To be effective, a product must be applied properly. To select the correct spray nozzle for the job, first fully read the product label and look for information on droplet size, application rate, spray quality, and environmental restrictions.



1) Spraying Technique:

Broadcast spraying is when the entire field is to be treated. The width that each nozzle sprays, adjusted for spray overlap, is the distance between nozzles on the spray boom.

Band spraying is when planted rows or unplanted gaps are treated. The width that each nozzle sprays is the width of the treated band.

2) Sprayer Speed:

Forward speed of the spraying machine should be measured accurately. Speed can be determined if it is known how long it takes to drive a measured distance:

$$\text{Speed in Kmph} = \frac{\text{distance (m)} \times 3.6}{\text{time (seconds)}}$$

or

$$\text{Speed in MPH} = \frac{\text{distance (feet)} \times 60}{\text{time (seconds)} \times 88}$$

12 km/h (20 mph)
(6-12 km/h or 10-20 mph)
(3-6 km/h or 5-10 mph)

Improved vehicle design means that speeds up to 12km/h (20 MPH) are now possible. Higher speeds 6-12km/h (10-20 MPH) improve work rates and timeliness; lower speeds 3-6 km/h (5-10 MPH) give improved canopy penetration and make spray drift control simpler.

3) Application Rate:

Read the product label closely to determine an appropriate spray application rate. If a range of acceptable application rates is listed, choose a rate that best matches your situation.

4) Flow Rate:

Determine the exact flow required from each tip by calculating:

$$\text{LPM} = \frac{\text{L/ha} \times \text{Km/h} \times \text{w}}{600}$$

or

$$\text{GPM} = \frac{\text{GPA} \times \text{MPH} \times \text{w}}{5,940}$$

'W' changes depending on the type of applications:

- Nozzle spacing (m/in) for broadcast spraying
- Spray width (m/in) for single-nozzle band spraying or boomless spraying
- Row spacing (m/in) divided by the number of nozzles per row for directed spraying

Or you can read the application tables throughout this guide.

Selecting the Right Sprayer Nozzle

5) Spray Pattern Type:

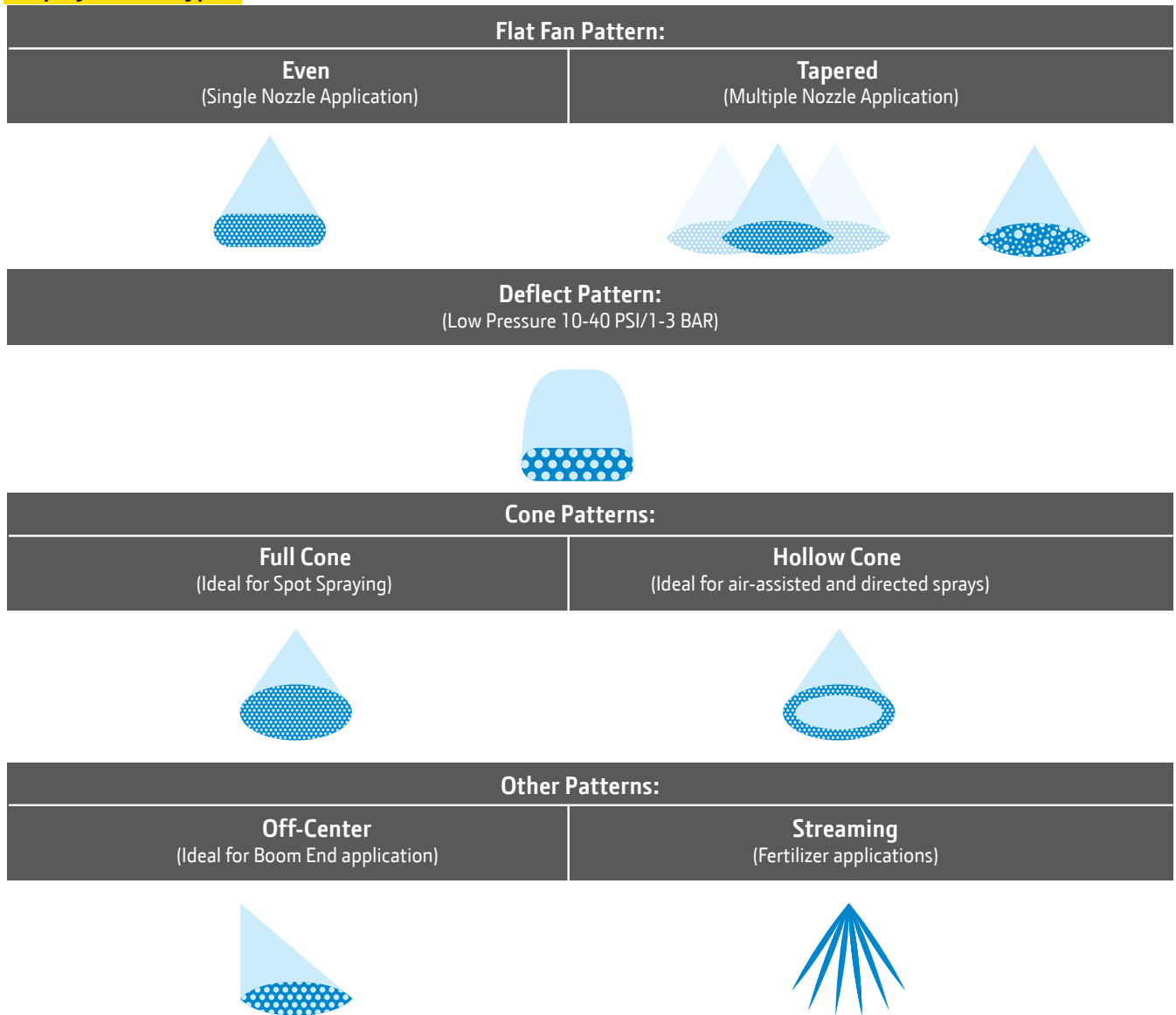

Nozzle Technology:

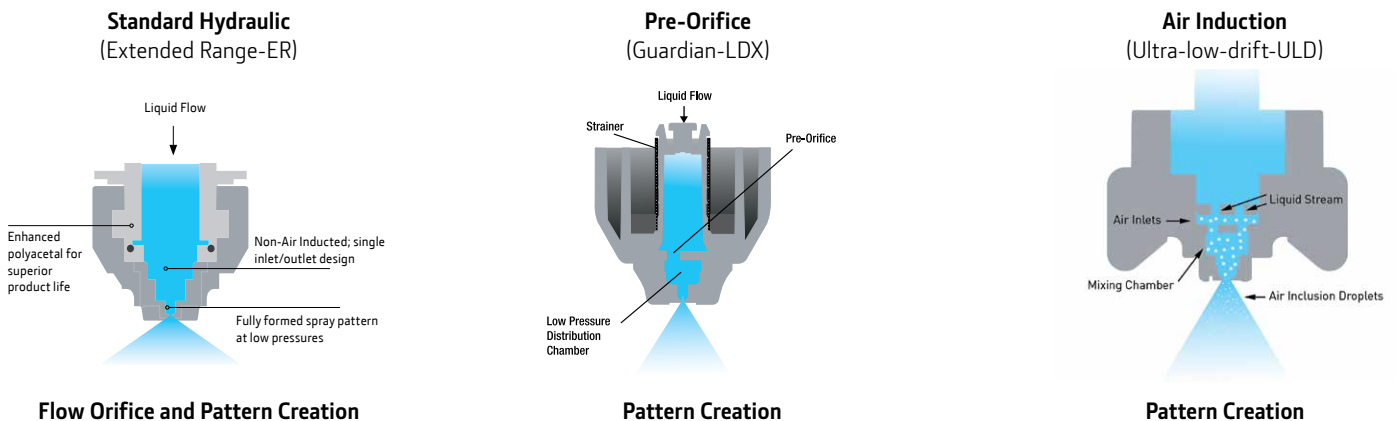

- Pro - Low cost
- Con - Increased drift potential

- Pro - Reduced drift potential
- Con - Multiple pieces to clean

- Pro - Increased coverage and reduced drift
- Con - Non-PWM compatible

Selecting the Right Sprayer Nozzle

6) Nozzle Size and Pressure:

Use the flow rate tables provided throughout this guide to select the nozzle and pressure that provides the flow needed for the application.

7) Spray Quality:

Use the flow rate tables provided throughout this guide to select the nozzle and pressure that provides the flow needed for the application.

ASABE S572.3 Droplet Size Classification

The American Society of Agricultural and Biological Engineers (ASABE) developed the ASABE S572.3 standard to measure and interpret spray quality from nozzles. The ASABE S572.3 standard uses eight droplet classification categories, six of which are common for agriculture and horticulture: Very Fine, Fine, Medium, Coarse, Very Coarse and Extremely Coarse. Most agrochemical applications recommend a fine, medium, or coarse spray.

Spray Quality*	Size of Droplets	Symbol	Colour Code	Retention on Difficult to Wet Leaves	Drift Potential
Extremely Fine	Small	XF	Purple	Excellent	High
Very Fine		VF	Red	Excellent	
Fine		F	Orange	Very Good	
Medium		M	Yellow	Good	
Coarse		C	Green	Moderate	
Very Coarse		VC	Blue	Poor	
Extremely Coarse		XC	White	Very Poor	
Ultra Coarse	Large	UC	Black	Very Poor	Low

*Always read the manufacturers label to determine which spray quality is required.

** Estimated from sample reference graph in ASABE/ANSI/ASAE Standard S572.3.

Driftable Fine Droplets

Droplets <141 microns are classified as highly driftable. Droplets that measure less than 141 microns are small enough that they weigh very little, are small in circumference and therefore will be transported by wind very easily and can evaporate quickly if the weather conditions are right.

The importance of droplets < 141 microns for an applicator would be:

When using nozzles that produce a high percentage of driftable fine droplets there is not only risk for downwind drift to injure neighbouring vegetation but also agronomic risk of reduced efficacy. Many of these droplets can evaporate before reaching their intended target. This can reduce the deposition on plant and soil surfaces, potentially reducing the agronomic efficacy of an application. Nozzles producing a high percentage of driftable fine droplets are not only a risk to your neighbours crops and any other vegetation nearby, but can also be a limiting factor in crop yield potential. When possible, using nozzles that produce fewer driftable fine droplets is a good practice to improve the performance of your sprayer.

Selecting the Right Sprayer Nozzle

The following chart has been designed to simplify selection of the correct spray nozzle type for the agrochemical to be applied. It is based on having good conditions for spraying and should be used in conjunction with the agrochemical manufacturer's label. Increased carrier rates may allow for coarser sprays to reduce risk of drift. Always follow the agrochemical label exactly.

- Lower spraying pressures provide larger droplet sizes, while higher spraying pressures yield smaller droplet sizes
- The smallest droplet sizes are achieved by air atomising nozzles
- Generally speaking, the largest spray droplets are produced by wide-angle, flat hydraulic spray nozzles

John Deere Spray Nozzle Selection Guide

Section	Code	Spray Nozzle	Common Use	Pattern	Technology	Orifice Material	Nominal Spray Angle	Pressure Range		ASABE Droplet Classification								
								PSI	BAR	XF	VF	F	M	C	VC	XC	UC	
Broadcast	3D	3D	Plant Health	Alternating Tapered Flat Fans	Advanced Tapered Flat Fan	Polyacetal	100	12-90	7-6									
	LDM	Low-drift Max	Weeds	Tapered Flat Fan	Pre-Orifice	Polyacetal	120	30-100	2-7									
	LDT	Low-drift Twin	Plant Health	Twin incline, Tapered Flat Fan	Pre-Orifice	Polyacetal	110	15-70	1-5									
	ULD	Ultra-low-drift Max	Weeds	Tapered Flat Fan	Air Induction	Polyacetal	130	30-100	2-7									
	ULD	Ultra-low-drift	Weeds	Tapered Flat Fan	Air Induction	Polyacetal	120	15-115	1-8									
	GAT	GuardianAIR Twin™	Plant Health	Tapered Flat Fan	Air Induction	Polyacetal	110	30-115	2-8									
	LDA	Low-drift Air	Plant Health	Tapered Flat Fan	Air Induction	Polyacetal	110	20-115	1-8									
	LDX	Guardian™	Plant Health	Tapered Flat Fan	Pre-Orifice	Polyacetal	120	15-115	1-8									
	LD	Low-drift	Plant Health	Tapered Flat Fan	Pre-Orifice	Polyacetal	80, 110	15-70	1-5									
	ER	Extended Range	General	Tapered Flat Fan	Elliptical Orifice	Polyacetal	80, 110	15-70	1-5									
Wide	FF	Flat Fan	General	Tapered Flat Fan	Elliptical Orifice	Polyacetal	80, 110	30-60	2-4									
	HF	High Flow	Fertilizer	Tapered Flat Fan	Pre-Orifice	Polyacetal	140	20-80	1.5 - 6									
	FL	Flood	Weeds and Fertilizer	Flood	Deflection	Polyacetal	80 to 160	10-60	1-4									
	STC	Straight Stream Ceramic	Fertilizer	Stream	Pre-Orifice	Ceramic	110 Equivalent	15-60	1-4								S	
Stream	ST	Straight Stream	Fertilizer	Stream	Round-Orifice	PVDF	110 Equivalent	15-60	1-4								S	
	D-C	Flow-Regulating Disc	Fertilizer	Stream	Round Orifice	Polyacetal	0	10-150	1-10								S	
	D-C	Disc and Core	Plant Health	Hollow Cone	Swirl	Polyacetal	25 to 110	10-150	1-10									
Banding & Directed	ES	Even Spray	Weeds	Even Flat Fan	Elliptical Orifice	Polyacetal	80	30-60	2-4									
	OC	Off-Center	Unspecialized	Off-center Fan	Elliptical Orifice	Brass	80	30-60	2-4									
Special	XT	Fence row/boomless	Weeds	Boomless Fan	Pre-Orifice	Polyacetal or Stainless	105	30-60	2-4									
	CR	Chemical Resistant	Acid Defoliants	Tapered Flat Fan	Pre-Orifice	PVDF	110	30-60	2-4									

S - These nozzles produce streams to minimise atomization
Classifications are subject to change

ASABE S572.3 Classification

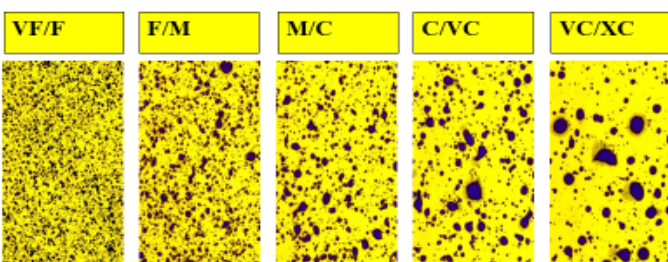

Colour Code	Classifications
XF	Extremely Fine
VF	Very Fine
F	Fine
M	Medium
C	Coarse
VC	Very Coarse
XC	Extremely Coarse
UC	Ultra Coarse

John Deere Label Information

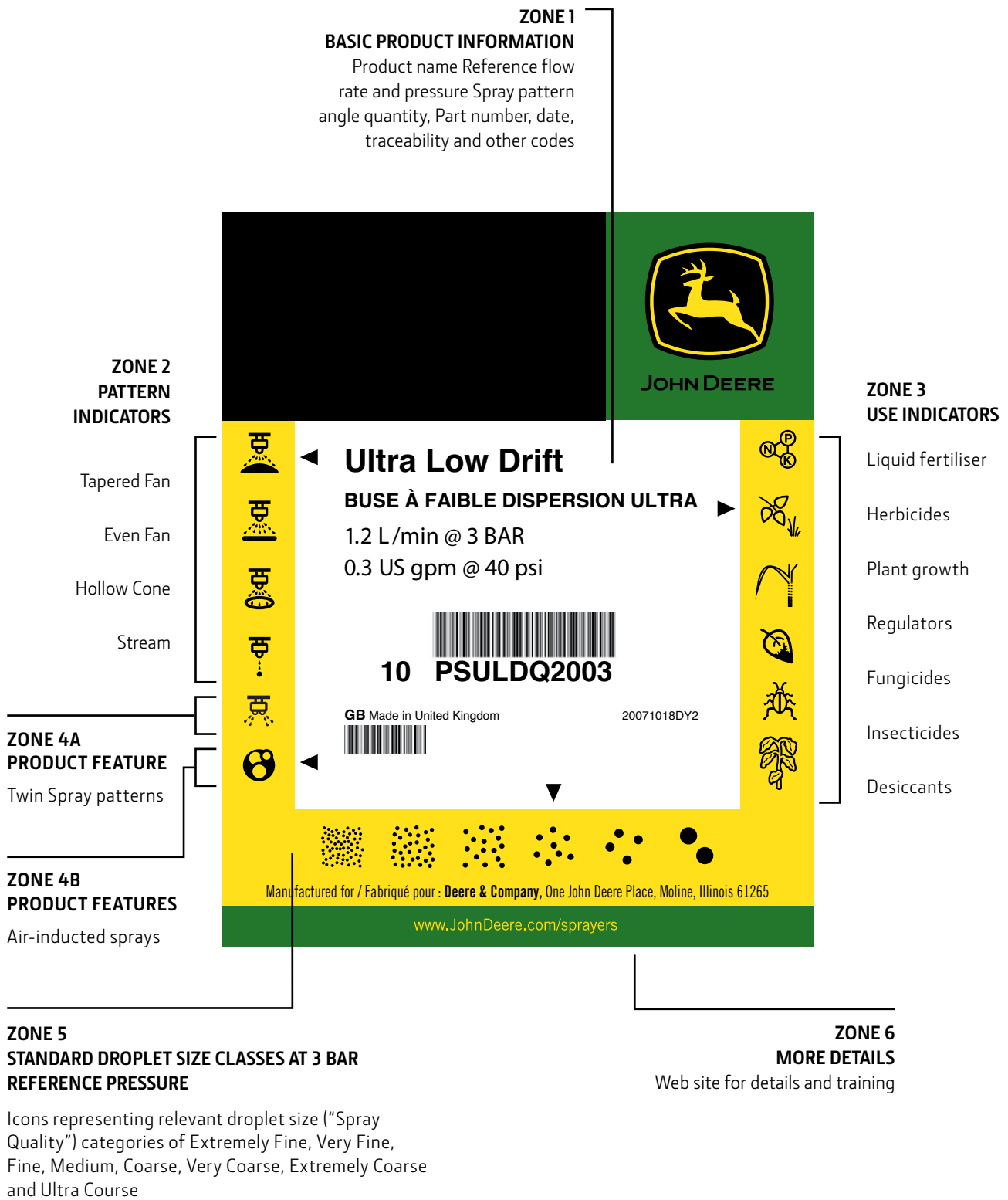

Symbols used may vary depending on spray nozzle types.

Primary Nozzles

A JOHN DEERE NOZZLE FOR EVERY APPLICATION

Throughout pre or post-emerge phases, our high-quality focus nozzles will deliver exactly the volumes and patterns you need for healthy crop growth. Choose the performance characteristics that suit you best.

PRE- AND POST-EMERGENCE FERTILISER, BURN-DOWN

HIGH-FLOW



- Wide 140° pattern allows lower boom height to minimise corrosive effects on equipment
- Tapered wide-angled fan style promotes uniform nutrient application
- Large droplets reduce drift better than flood or deflect nozzles

ExactApply compatible with 15Hz and 30Hz PWM, AutoSelect A/B and conventional spraying

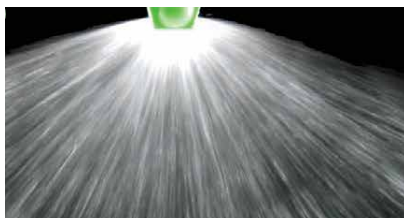

PRE- AND POST-EMERGE SYSTEMIC HERBICIDES

ULTRA LOW-DRIFT



- Ideal for use when drift reduction is paramount (included on dicamba and 2,4-D chemical labels)
- Air-induced droplets provide precise droplet control to minimize drift potential without sacrificing coverage
- 60° thick spray pattern and 120° wide spray angle enables lower boom height to further decrease drift

ExactApply compatible with AutoSelect A/B and conventional spraying



ALL-PURPOSE COVERAGE NOZZLE

3D



- Delivers up to 10% increase in weed control over conventional flat fans
- Provides 50-75% less drift compared to flat fan nozzles
- Tight, inclined spray pattern (designed for alternating forward and backward installation) provides 3-dimensional coverage on hard-to-hit targets
- High-velocity droplets provide excellent canopy penetration

ExactApply compatible with 15Hz and 30Hz PWM, AutoSelect A/B and conventional spraying



Primary Nozzles

A JOHN DEERE NOZZLE FOR EVERY APPLICATION

POST-EMERGENCE
SYSTEMIC APPLICATIONS

LOW-DRIFT MAX



- 120° wide and 60° thick pattern provides optimum coverage while maintaining overlap at lower boom heights
- Dual pre-orifice nozzle reduces drift with coarse, very coarse and extremely coarse droplets
- **Industry exclusive from John Deere**

ExactApply compatible with 15Hz and 30Hz PWM, AutoSelect A/B and conventional spraying



PLANT HEALTH AND
CONTACT HERBICIDES

LOW-DRIFT TWIN



- Twin 30° forward and rear facing dual angles for superior coverage
- Medium and coarse droplets across wide operating range and sizes to meet speed/rate needs
- **Industry exclusive from John Deere**

ExactApply compatible with 15Hz and 30Hz PWM, AutoSelect A/B and conventional spraying



POST-EMERGE SYSTEMIC
HERBICIDE APPLICATIONS
(WHERE DRIFT REDUCTION IS FOREMOST)

ULTRA LOW-DRIFT MAX



- 130° spray angle allows lower boom heights to reduce drift and to prevent pattern collapse when using drift-reduction adjuvants
- Air-induction droplets to reduce drift
- Extremely coarse and ultra coarse droplets for 90-95% drift reduction compared to standard flat fan nozzle

ExactApply compatible with 15Hz and 30Hz PWM, AutoSelect A/B and conventional spraying





Primary Nozzles

HIGH-FLOW (HF) 140°

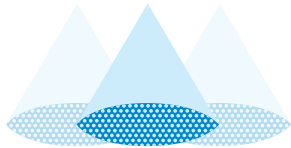

The High-flow (HF) nozzle is a premium choice for pre-plant liquid fertilizers, including the use of fertilizer blends with pre-emergent herbicides for “burndown”. The wide 140° pattern allows a low boom height, minimizing corrosive effects on application equipment. A tapered, wide-angle, fan style promotes uniform nutrient application.

- Features a removable pre-orifice for in-field cleaning
- Straight-through design helps reduce clogging and drift
- Quick-change nozzle assembly includes tip and cap (one piece) and gasket.

High-flow (HF) 140° spray angle - ASABE droplet size classification chart

Tip size		08	10	15	20	30	40	50	60
Part Number		PSHFQ4008	PSHFQ4010	PSHFQ4015	PSHFQ4020	PSHFQ4030	PSHFQ4040	PSHFQ4050	PSHFQ4060
Pressure (Bar)	Pressure (PSI)								
1.4	20	UC	UC	UC	UC	UC	UC	UC	UC
2.0	30	UC	UC	UC	UC	UC	UC	UC	UC
2.8	40	UC	UC	UC	UC	UC	UC	UC	UC
3.4	50	UC	UC	UC	UC	UC	UC	UC	UC
4.1	60	XC	XC	XC	XC	XC	XC	XC	XC
4.8	70	XC	XC	XC	XC	XC	XC	XC	XC
5.5	80	XC	XC	XC	XC	XC	XC	XC	XC
5.9	85	XC	XC	XC	XC	XC	XC	XC	XC

Droplet data sourced at Silsoe Spray Applications Unit Ltd in a steady state condition per ASABE S572.3.

Features	
Common Use	Liquid Fertilizer
Pattern	Tapered Flat Fan
Technology	Pre-orifice
Material	Polyacetal
Spray Angle	140°
Pressure Range	1.4 - 5.9 Bar (20-85 PSI)
Configuration	Quick Change

ExactApply™ Compatibility	
15Hz PWM	Yes
30Hz PWM	Yes
AutoSelect A/B	Yes
Conventional	Yes

Optimum Boom Height	
Nozzle Spacing	Boom Height
38cm	25cm
50cm	30cm

Service Parts	
Cap gasket	PM65BS205

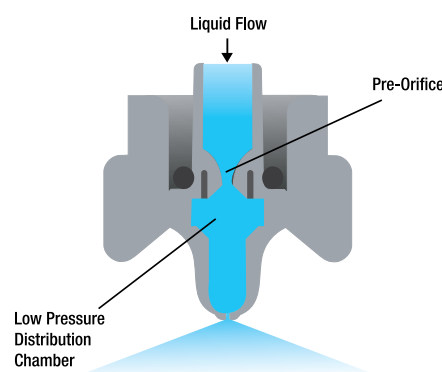

Primary Nozzles

HIGH-FLOW APPLICATION CHART - 25CM NOZZLE SPACING

TIP SIZE	ASABE DROPLET SIZE	PRESSURE (BAR)	FLOW RATE (LPM)	APPLICATION RATE L/HA - 25 CM SPACING KM/H									
				8	10	12	14	15	20	25	30	35	40
08	UC	1.5	2.26	678	542	452	387	362	271	217	181	155	136
	UC	2	2.61	783	626	522	447	418	313	251	209	179	157
	UC	3	3.20	960	768	640	549	512	384	307	256	219	192
	XC	4	3.70	1110	888	740	634	592	444	355	296	254	222
	XC	5	4.13	1239	991	826	708	661	496	396	330	283	248
	XC	6	4.53	1359	1087	906	777	725	544	435	362	311	272
10	UC	1.5	2.80	840	672	560	480	448	336	269	224	192	168
	UC	2	3.30	990	792	660	566	528	396	317	264	226	198
	UC	3	4.00	1200	960	800	686	640	480	384	320	274	240
	XC	4	4.60	1380	1104	920	789	736	552	442	368	315	276
	XC	5	5.20	1560	1248	1040	891	832	624	499	416	357	312
	XC	6	5.70	1710	1368	1140	977	912	684	547	456	391	342
15	UC	1.5	4.20	1260	1008	840	720	672	504	403	336	288	252
	UC	2	4.90	1470	1176	980	840	784	588	470	392	336	294
	UC	3	6.00	1800	1440	1200	1029	960	720	576	480	411	360
	XC	4	6.90	2070	1656	1380	1183	1104	828	662	552	473	414
	XC	5	7.70	2310	1848	1540	1320	1232	924	739	616	528	462
	XC	6	8.50	2550	2040	1700	1457	1360	1020	816	680	583	510
20	UC	1.5	5.70	1710	1368	1140	977	912	684	547	456	391	342
	UC	2	6.50	1950	1560	1300	1114	1040	780	624	520	446	390
	UC	3	8.00	2400	1920	1600	1371	1280	960	768	640	549	480
	XC	4	9.20	2760	2208	1840	1577	1472	1104	883	736	631	552
	XC	5	10.30	3090	2472	2060	1766	1648	1236	989	824	706	618
	XC	6	11.30	3390	2712	2260	1937	1808	1356	1085	904	775	678
30	UC	1.5	8.50	2550	2040	1700	1457	1360	1020	816	680	583	510
	UC	2	9.80	2940	2352	1960	1680	1568	1176	941	784	672	588
	UC	3	12.00	3600	2880	2400	2057	1920	1440	1152	960	823	720
	XC	4	13.90	4170	3336	2780	2383	2224	1668	1334	1112	953	834
	XC	5	15.50	4650	3720	3100	2657	2480	1860	1488	1240	1063	930
	XC	6	17.00	5100	4080	3400	2914	2720	2040	1632	1360	1166	1020
40	UC	1.5	11.30	3390	2712	2260	1937	1808	1356	1085	904	775	678
	UC	2	13.10	3930	3144	2620	2246	2096	1572	1258	1048	898	786
	UC	3	16.00	4800	3840	3200	2743	2560	1920	1536	1280	1097	960
	XC	4	18.50	5550	4440	3700	3171	2960	2220	1776	1480	1269	1110
	XC	5	20.70	6210	4968	4140	3549	3312	2484	1987	1656	1419	1242
	XC	6	22.60	6780	5424	4520	3874	3616	2712	2170	1808	1550	1356
50	UC	1.5	14.10	4230	3384	2820	2417	2256	1692	1354	1128	967	846
	UC	2	16.30	4890	3912	3260	2794	2608	1956	1565	1304	1118	978
	UC	3	20.00	6000	4800	4000	3429	3200	2400	1920	1600	1371	1200
	XC	4	23.10	6930	5544	4620	3960	3696	2772	2218	1848	1584	1386
	XC	5	25.80	7740	6192	5160	4423	4128	3096	2477	2064	1769	1548
	XC	6	28.30	8490	6792	5660	4851	4528	3396	2717	2264	1941	1698
60	UC	1.5	17.00	5100	4080	3400	2914	2720	2040	1632	1360	1166	1020
	UC	2	19.60	5880	4704	3920	3360	3136	2352	1882	1568	1344	1176
	UC	3	24.00	7200	5760	4800	4114	3840	2880	2304	1920	1646	1440
	XC	4	27.70	8310	6648	5540	4749	4432	3324	2659	2216	1899	1662
	XC	5	31.00	9300	7440	6200	5314	4960	3720	2976	2480	2126	1860
	XC	6	33.90	10170	8136	6780	5811	5424	4068	3254	2712	2325	2034

Primary Nozzles

HIGH-FLOW APPLICATION CHART - 38CM NOZZLE SPACING

TIP SIZE	ASABE DROPLET SIZE	PRESSURE (BAR)	FLOW RATE (LPM)	APPLICATION RATE L/HA - 38 CM SPACING KM/H									
				8	10	12	14	15	20	25	30	35	40
08	UC	1.5	2.26	446	357	297	255	238	178	143	119	102	89
	UC	2	2.61	515	412	343	294	275	206	165	137	118	103
	UC	3	3.20	632	505	421	361	337	253	202	168	144	126
	XC	4	3.70	730	584	487	417	389	292	234	195	167	146
	XC	5	4.13	815	652	543	466	435	326	261	217	186	163
	XC	6	4.53	894	715	596	511	477	358	286	238	204	179
10	UC	1.5	2.80	553	442	368	316	295	221	177	147	126	111
	UC	2	3.30	651	521	434	372	347	261	208	174	149	130
	UC	3	4.00	789	632	526	451	421	316	253	211	180	158
	XC	4	4.60	908	726	605	519	484	363	291	242	208	182
	XC	5	5.20	1026	821	684	586	547	411	328	274	235	205
	XC	6	5.70	1125	900	750	643	600	450	360	300	257	225
15	UC	1.5	4.20	829	663	553	474	442	332	265	221	189	166
	UC	2	4.90	967	774	645	553	516	387	309	258	221	193
	UC	3	6.00	1184	947	789	677	632	474	379	316	271	237
	XC	4	6.90	1362	1089	908	778	726	545	436	363	311	272
	XC	5	7.70	1520	1216	1013	868	811	608	486	405	347	304
	XC	6	8.50	1678	1342	1118	959	895	671	537	447	383	336
20	UC	1.5	5.70	1125	900	750	643	600	450	360	300	257	225
	UC	2	6.50	1283	1026	855	733	684	513	411	342	293	257
	UC	3	8.00	1579	1263	1053	902	842	632	505	421	361	316
	XC	4	9.20	1816	1453	1211	1038	968	726	581	484	415	363
	XC	5	10.30	2033	1626	1355	1162	1084	813	651	542	465	407
	XC	6	11.30	2230	1784	1487	1274	1189	892	714	595	510	446
30	UC	1.5	8.50	1678	1342	1118	959	895	671	537	447	383	336
	UC	2	9.80	1934	1547	1289	1105	1032	774	619	516	442	387
	UC	3	12.00	2368	1895	1579	1353	1263	947	758	632	541	474
	XC	4	13.90	2743	2195	1829	1568	1463	1097	878	732	627	549
	XC	5	15.50	3059	2447	2039	1748	1632	1224	979	816	699	612
	XC	6	17.00	3355	2684	2237	1917	1789	1342	1074	895	767	671
40	UC	1.5	11.30	2230	1784	1487	1274	1189	892	714	595	510	446
	UC	2	13.10	2586	2068	1724	1477	1379	1034	827	689	591	517
	UC	3	16.00	3158	2526	2105	1805	1684	1263	1011	842	722	632
	XC	4	18.50	3651	2921	2434	2086	1947	1461	1168	974	835	730
	XC	5	20.70	4086	3268	2724	2335	2179	1634	1307	1089	934	817
	XC	6	22.60	4461	3568	2974	2549	2379	1784	1427	1189	1020	892
50	UC	1.5	14.10	2783	2226	1855	1590	1484	1113	891	742	636	557
	UC	2	16.30	3217	2574	2145	1838	1716	1287	1029	858	735	643
	UC	3	20.00	3947	3158	2632	2256	2105	1579	1263	1053	902	789
	XC	4	23.10	4559	3647	3039	2605	2432	1824	1459	1216	1042	912
	XC	5	25.80	5092	4074	3395	2910	2716	2037	1629	1358	1164	1018
	XC	6	28.30	5586	4468	3724	3192	2979	2234	1787	1489	1277	1117
60	UC	1.5	17.00	3355	2684	2237	1917	1789	1342	1074	895	767	671
	UC	2	19.60	3868	3095	2579	2211	2063	1547	1238	1032	884	774
	UC	3	24.00	4737	3789	3158	2707	2526	1895	1516	1263	1083	947
	XC	4	27.70	5467	4374	3645	3124	2916	2187	1749	1458	1250	1093
	XC	5	31.00	6118	4895	4079	3496	3263	2447	1958	1632	1398	1224
	XC	6	33.90	6691	5353	4461	3823	3568	2676	2141	1784	1529	1338

Primary Nozzles

HIGH-FLOW APPLICATION CHART - 50CM NOZZLE SPACING

TIP SIZE	ASABE DROPLET SIZE	PRESSURE (BAR)	FLOW RATE (LPM)	APPLICATION RATE L/HA - 50 CM SPACING KM/H									
				8	10	12	14	15	20	25	30	35	40
08	UC	1.5	2.26	339	271	226	194	181	136	108	90	77	68
	UC	2	2.61	392	313	261	224	209	157	125	104	89	78
	UC	3	3.20	480	384	320	274	256	192	154	128	110	96
	XC	4	3.70	555	444	370	317	296	222	178	148	127	111
	XC	5	4.13	620	496	413	354	330	248	198	165	142	124
	XC	6	4.53	680	544	453	388	362	272	217	181	155	136
10	UC	1.5	2.80	420	336	280	240	224	168	134	112	96	84
	UC	2	3.30	495	396	330	283	264	198	158	132	113	99
	UC	3	4.00	600	480	400	343	320	240	192	160	137	120
	XC	4	4.60	690	552	460	394	368	276	221	184	158	138
	XC	5	5.20	780	624	520	446	416	312	250	208	178	156
	XC	6	5.70	855	684	570	489	456	342	274	228	195	171
15	UC	1.5	4.20	630	504	420	360	336	252	202	168	144	126
	UC	2	4.90	735	588	490	420	392	294	235	196	168	147
	UC	3	6.00	900	720	600	514	480	360	288	240	206	180
	XC	4	6.90	1035	828	690	591	552	414	331	276	237	207
	XC	5	7.70	1155	924	770	660	616	462	370	308	264	231
	XC	6	8.50	1275	1020	850	729	680	510	408	340	291	255
20	UC	1.5	9.75	1463	1170	975	836	780	585	468	390	334	293
	UC	2	10.75	1613	1290	1075	921	860	645	516	430	369	323
	UC	3	11.75	1763	1410	1175	1007	940	705	564	470	403	353
	XC	4	12.75	1913	1530	1275	1093	1020	765	612	510	437	383
	XC	5	13.75	2063	1650	1375	1179	1100	825	660	550	471	413
	XC	6	14.75	2213	1770	1475	1264	1180	885	708	590	506	443
30	UC	1.5	16.75	2513	2010	1675	1436	1340	1005	804	670	574	503
	UC	2	17.75	2663	2130	1775	1521	1420	1065	852	710	609	533
	UC	3	18.75	2813	2250	1875	1607	1500	1125	900	750	643	563
	XC	4	19.75	2963	2370	1975	1693	1580	1185	948	790	677	593
	XC	5	20.75	3113	2490	2075	1779	1660	1245	996	830	711	623
	XC	6	21.75	3263	2610	2175	1864	1740	1305	1044	870	746	653
40	UC	1.5	23.75	3563	2850	2375	2036	1900	1425	1140	950	814	713
	UC	2	24.75	3713	2970	2475	2121	1980	1485	1188	990	849	743
	UC	3	25.75	3863	3090	2575	2207	2060	1545	1236	1030	883	773
	XC	4	26.75	4013	3210	2675	2293	2140	1605	1284	1070	917	803
	XC	5	27.75	4163	3330	2775	2379	2220	1665	1332	1110	951	833
	XC	6	28.75	4313	3450	2875	2464	2300	1725	1380	1150	986	863
50	UC	1.5	30.75	4613	3690	3075	2636	2460	1845	1476	1230	1054	923
	UC	2	31.75	4763	3810	3175	2721	2540	1905	1524	1270	1089	953
	UC	3	32.75	4913	3930	3275	2807	2620	1965	1572	1310	1123	983
	XC	4	33.75	5063	4050	3375	2893	2700	2025	1620	1350	1157	1013
	XC	5	34.75	5213	4170	3475	2979	2780	2085	1668	1390	1191	1043
	XC	6	35.75	5363	4290	3575	3064	2860	2145	1716	1430	1226	1073
60	UC	1.5	37.75	5663	4530	3775	3236	3020	2265	1812	1510	1294	1133
	UC	2	38.75	5813	4650	3875	3321	3100	2325	1860	1550	1329	1163
	UC	3	39.75	5963	4770	3975	3407	3180	2385	1908	1590	1363	1193
	XC	4	40.75	6113	4890	4075	3493	3260	2445	1956	1630	1397	1223
	XC	5	41.75	6263	5010	4175	3579	3340	2505	2004	1670	1431	1253
	XC	6	42.75	6413	5130	4275	3664	3420	2565	2052	1710	1466	1283



Primary Nozzles

ULTRA-LOW-DRIFT (ULD) 120°



The Ultra-low-drift (ULD) is the ideal spray nozzle for pre- and post-emergence product applications, where drift reduction is paramount. A unique thick spray pattern, measuring nearly 60° front to back, coupled with the 120° wide spray angle, enables the boom height to be lowered to further decrease drift potential.

- Creates air-filled droplets to significantly reduce spray drift potential
- Small, compact size compared to traditional air-induction nozzles, reduces the chances of accidental breakage
- Quick-change nozzle assembly includes tip, cap, gasket, and integrated strainer for easy installation

Ultra-low-drift (ULD) 120 degree spray angle - ASABE droplet size classification chart

Tip size	015	02	025	03	04	05	06	08
Part Number	PSULDQ20015	PSULDQ2002	PSULDQ20025	PSULDQ2003	PSULDQ2004	PSULDQ2005	PSULDQ2006	PSULDQ2008
Tip Number	PSULD20015	PSULD2002	PSULD20025	PSULD2003	PSULD2004	PSULD2005	PSULD2006	PSULD2008
Cap Number	PS900015	PS90002	PS900025	PS90003	PS90004	PS90005	PS90006	PS90008
Pressure (Bar)	Pressure (PSI)							
1.4	20	UC	UC	UC	UC	UC	UC	UC
2.0	30	XC	XC	VC	VC	UC	UC	XC
2.8	40	VC	VC	C	C	UC	XC	VC
3.4	50	VC	VC	C	C	XC	XC	VC
4.1	60	C	C	M	C	XC	VC	C
4.8	70	C	M	M	M	XC	VC	C
5.5	80	C	M	M	M	VC	VC	C
6.2	90	M	M	M	M	VC	VC	M
6.9	100	M	M	M	M	VC	C	M
7.9	115	M	M	M	M	C	C	M

Droplet data sourced at Silsoe Spray Applications Unit Ltd in a steady state condition per ASABE S572.3 Standard.

Features	
Common Use	Systemic Herbicide
Pattern	Tapered Flat Fan
Technology	Air Induction
Material	Polycetal
Spray Angle	120°
Pressure Range	1.4 - 7.9 Bar (20-115 PSI)
Configuration	Quick Change

ExactApply™ Compatibility	
15Hz PWM	No
30Hz PWM	No
AutoSelect A/B	Yes
Conventional	Yes

Service Parts	
Cap gasket	PS17000255
Strainer (50 mesh)	PS310

Optimum Boom Height	
Nozzle Spacing	Boom Height
38cm	33cm
50cm	45cm

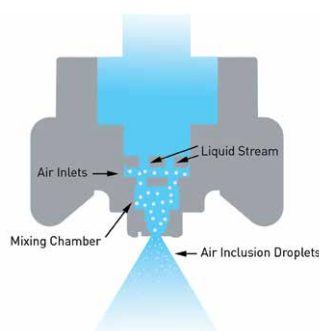

Primary Nozzles

ULTRA-LOW-DRIFT APPLICATION CHART - 25CM NOZZLE SPACING

TIP SIZE	ASABE DROPLET SIZE	PRESSURE (BAR)	FLOW RATE (LPM)	APPLICATION RATE L/HA - 25 CM SPACING KM/H									
				8	10	12	14	15	20	25	30	35	40
015	UC	1.5	0.42	126	101	84	72	67	50	40	34	29	25
	EC	2	0.49	147	118	98	84	78	59	47	39	34	29
	VC	3	0.60	180	144	120	103	96	72	58	48	41	36
	C	4	0.69	207	166	138	118	110	83	66	55	47	41
	C	5	0.77	231	185	154	132	123	92	74	62	53	46
	M	6	0.85	255	204	170	146	136	102	82	68	58	51
	M	7	0.92	276	221	184	158	147	110	88	74	63	55
	M	8	0.98	294	235	196	168	157	118	94	78	67	59
02	UC	1.5	0.57	171	137	114	98	91	68	55	46	39	34
	EC	2	0.65	195	156	130	111	104	78	62	52	45	39
	C	3	0.80	240	192	160	137	128	96	77	64	55	48
	C	4	0.92	276	221	184	158	147	110	88	74	63	55
	M	5	1.03	309	247	206	177	165	124	99	82	71	62
	M	6	1.13	339	271	226	194	181	136	108	90	77	68
	M	7	1.22	366	293	244	209	195	146	117	98	84	73
	M	8	1.31	393	314	262	225	210	157	126	105	90	79
025	EC	1.5	0.71	213	170	142	122	114	85	68	57	49	43
	EC	2	0.82	246	197	164	141	131	98	79	66	56	49
	C	3	1.00	300	240	200	171	160	120	96	80	69	60
	C	4	1.15	345	276	230	197	184	138	110	92	79	69
	M	5	1.29	387	310	258	221	206	155	124	103	88	77
	M	6	1.41	423	338	282	242	226	169	135	113	97	85
	M	7	1.53	459	367	306	262	245	184	147	122	105	92
	M	8	1.63	489	391	326	279	261	196	156	130	112	98
03	EC	1.5	0.85	255	204	170	146	136	102	82	68	58	51
	EC	2	0.98	294	235	196	168	157	118	94	78	67	59
	C	3	1.20	360	288	240	206	192	144	115	96	82	72
	C	4	1.39	417	334	278	238	222	167	133	111	95	83
	M	5	1.55	465	372	310	266	248	186	149	124	106	93
	M	6	1.70	510	408	340	291	272	204	163	136	117	102
	M	7	1.83	549	439	366	314	293	220	176	146	125	110
	M	8	1.96	588	470	392	336	314	235	188	157	134	118
04	UC	1.5	1.13	339	271	226	194	181	136	108	90	77	68
	UC	2	1.31	393	314	262	225	210	157	126	105	90	79
	UC	3	1.60	480	384	320	274	256	192	154	128	110	96
	EC	4	1.85	555	444	370	317	296	222	178	148	127	111
	EC	5	2.07	621	497	414	355	331	248	199	166	142	124
	VC	6	2.26	678	542	452	387	362	271	217	181	155	136
	C	7	2.44	732	586	488	418	390	293	234	195	167	146
	C	8	2.61	783	626	522	447	418	313	251	209	179	157

Continued on Next Page

Primary Nozzles

ULTRA-LOW-DRIFT APPLICATION CHART - 25CM NOZZLE SPACING (CONTINUED)

TIP SIZE	ASABE DROPLET SIZE	PRESSURE (BAR)	FLOW RATE (LPM)	APPLICATION RATE L/HA - 25 CM SPACING KM/H									
				8	10	12	14	15	20	25	30	35	40
05	UC	1.5	1.41	423	338	282	242	226	169	135	113	97	85
	UC	2	1.63	489	391	326	279	261	196	156	130	112	98
	EC	3	2.00	600	480	400	343	320	240	192	160	137	120
	EC	4	2.31	693	554	462	396	370	277	222	185	158	139
	VC	5	2.58	774	619	516	442	413	310	248	206	177	155
	VC	6	2.83	849	679	566	485	453	340	272	226	194	170
	C	7	3.06	918	734	612	525	490	367	294	245	210	184
	C	8	3.27	981	785	654	561	523	392	314	262	224	196
06	UC	1.5	1.70	510	408	340	291	272	204	163	136	117	102
	UC	2	1.96	588	470	392	336	314	235	188	157	134	118
	EC	3	2.40	720	576	480	411	384	288	230	192	165	144
	VC	4	2.77	831	665	554	475	443	332	266	222	190	166
	C	5	3.10	930	744	620	531	496	372	298	248	213	186
	C	6	3.39	1017	814	678	581	542	407	325	271	232	203
	C	7	3.67	1101	881	734	629	587	440	352	294	252	220
	M	8	3.92	1176	941	784	672	627	470	376	314	269	235
08	UC	1.5	2.26	678	542	452	387	362	271	217	181	155	136
	EC	2	2.61	783	626	522	447	418	313	251	209	179	157
	VC	3	3.20	960	768	640	549	512	384	307	256	219	192
	C	4	3.70	1110	888	740	634	592	444	355	296	254	222
	C	5	4.13	1239	991	826	708	661	496	396	330	283	248
	M	6	4.53	1359	1087	906	777	725	544	435	362	311	272
	M	7	4.89	1467	1174	978	838	782	587	469	391	335	293
	M	8	5.23	1569	1255	1046	897	837	628	502	418	359	314

Primary Nozzles

ULTRA-LOW-DRIFT APPLICATION CHART - 38CM NOZZLE SPACING

TIP SIZE	ASABE DROPLET SIZE	PRESSURE (BAR)	FLOW RATE (LPM)	APPLICATION RATE L/HA - 38 CM SPACING KM/H									
				8	10	12	14	15	20	25	30	35	40
015	UC	1.5	0.42	83	66	55	47	44	33	27	22	19	17
	EC	2	0.49	97	77	64	55	52	39	31	26	22	19
	VC	3	0.60	118	95	79	68	63	47	38	32	27	24
	C	4	0.69	136	109	91	78	73	54	44	36	31	27
	C	5	0.77	152	122	101	87	81	61	49	41	35	30
	M	6	0.85	168	134	112	96	89	67	54	45	38	34
	M	7	0.92	182	145	121	104	97	73	58	48	42	36
	M	8	0.98	193	155	129	111	103	77	62	52	44	39
02	UC	1.5	0.57	113	90	75	64	60	45	36	30	26	23
	EC	2	0.65	128	103	86	73	68	51	41	34	29	26
	C	3	0.80	158	126	105	90	84	63	51	42	36	32
	C	4	0.92	182	145	121	104	97	73	58	48	42	36
	M	5	1.03	203	163	136	116	108	81	65	54	46	41
	M	6	1.13	223	178	149	127	119	89	71	59	51	45
	M	7	1.22	241	193	161	138	128	96	77	64	55	48
	M	8	1.31	259	207	172	148	138	103	83	69	59	52
025	EC	1.5	0.71	140	112	93	80	75	56	45	37	32	28
	EC	2	0.82	162	129	108	92	86	65	52	43	37	32
	C	3	1.00	197	158	132	113	105	79	63	53	45	39
	C	4	1.15	227	182	151	130	121	91	73	61	52	45
	M	5	1.29	255	204	170	145	136	102	81	68	58	51
	M	6	1.41	278	223	186	159	148	111	89	74	64	56
	M	7	1.53	302	242	201	173	161	121	97	81	69	60
	M	8	1.63	322	257	214	184	172	129	103	86	74	64
03	EC	1.5	0.85	168	134	112	96	89	67	54	45	38	34
	EC	2	0.98	193	155	129	111	103	77	62	52	44	39
	C	3	1.20	237	189	158	135	126	95	76	63	54	47
	C	4	1.39	274	219	183	157	146	110	88	73	63	55
	M	5	1.55	306	245	204	175	163	122	98	82	70	61
	M	6	1.70	336	268	224	192	179	134	107	89	77	67
	M	7	1.83	361	289	241	206	193	144	116	96	83	72
	M	8	1.96	387	309	258	221	206	155	124	103	88	77
04	UC	1.5	1.13	223	178	149	127	119	89	71	59	51	45
	UC	2	1.31	259	207	172	148	138	103	83	69	59	52
	UC	3	1.60	316	253	211	180	168	126	101	84	72	63
	EC	4	1.85	365	292	243	209	195	146	117	97	83	73
	EC	5	2.07	409	327	272	233	218	163	131	109	93	82
	VC	6	2.26	446	357	297	255	238	178	143	119	102	89
	C	7	2.44	482	385	321	275	257	193	154	128	110	96
	C	8	2.61	515	412	343	294	275	206	165	137	118	103

Continued on Next Page

Primary Nozzles

ULTRA-LOW-DRIFT APPLICATION CHART - 38CM NOZZLE SPACING (CONTINUED)

TIP SIZE	ASABE DROPLET SIZE	PRESSURE (BAR)	FLOW RATE (LPM)	APPLICATION RATE L/HA - 38 CM SPACING KM/H									
				8	10	12	14	15	20	25	30	35	40
05	UC	1.5	1.41	278	223	186	159	148	111	89	74	64	56
	UC	2	1.63	322	257	214	184	172	129	103	86	74	64
	EC	3	2.00	395	316	263	226	211	158	126	105	90	79
	EC	4	2.31	456	365	304	261	243	182	146	122	104	91
	VC	5	2.58	509	407	339	291	272	204	163	136	116	102
	VC	6	2.83	559	447	372	319	298	223	179	149	128	112
	C	7	3.06	604	483	403	345	322	242	193	161	138	121
	C	8	3.27	645	516	430	369	344	258	207	172	148	129
06	UC	1.5	1.70	336	268	224	192	179	134	107	89	77	67
	UC	2	1.96	387	309	258	221	206	155	124	103	88	77
	EC	3	2.40	474	379	316	271	253	189	152	126	108	95
	VC	4	2.77	547	437	364	312	292	219	175	146	125	109
	C	5	3.10	612	489	408	350	326	245	196	163	140	122
	C	6	3.39	669	535	446	382	357	268	214	178	153	134
	C	7	3.67	724	579	483	414	386	290	232	193	166	145
	M	8	3.92	774	619	516	442	413	309	248	206	177	155
08	UC	1.5	2.26	446	357	297	255	238	178	143	119	102	89
	EC	2	2.61	515	412	343	294	275	206	165	137	118	103
	VC	3	3.20	632	505	421	361	337	253	202	168	144	126
	C	4	3.70	730	584	487	417	389	292	234	195	167	146
	C	5	4.13	815	652	543	466	435	326	261	217	186	163
	M	6	4.53	894	715	596	511	477	358	286	238	204	179
	M	7	4.89	965	772	643	552	515	386	309	257	221	193
	M	8	5.23	1032	826	688	590	551	413	330	275	236	206

Primary Nozzles

ULTRA-LOW-DRIFT APPLICATION CHART - 50CM NOZZLE SPACING

TIP SIZE	ASABE DROPLET SIZE	PRESSURE (BAR)	FLOW RATE (LPM)	APPLICATION RATE L/HA - 50 CM SPACING KM/H									
				8	10	12	14	15	20	25	30	35	40
015	UC	1.5	0.42	63	50	42	36	34	25	20	17	14	13
	EC	2	0.49	74	59	49	42	39	29	24	20	17	15
	VC	3	0.60	90	72	60	51	48	36	29	24	21	18
	C	4	0.69	104	83	69	59	55	41	33	28	24	21
	C	5	0.77	116	92	77	66	62	46	37	31	26	23
	M	6	0.85	128	102	85	73	68	51	41	34	29	26
	M	7	0.92	138	110	92	79	74	55	44	37	32	28
	M	8	0.98	147	118	98	84	78	59	47	39	34	29
02	UC	1.5	0.57	86	68	57	49	46	34	27	23	20	17
	EC	2	0.65	98	78	65	56	52	39	31	26	22	20
	C	3	0.80	120	96	80	69	64	48	38	32	27	24
	C	4	0.92	138	110	92	79	74	55	44	37	32	28
	M	5	1.03	155	124	103	88	82	62	49	41	35	31
	M	6	1.13	170	136	113	97	90	68	54	45	39	34
	M	7	1.22	183	146	122	105	98	73	59	49	42	37
	M	8	1.31	197	157	131	112	105	79	63	52	45	39
025	EC	1.5	0.71	107	85	71	61	57	43	34	28	24	21
	EC	2	0.82	123	98	82	70	66	49	39	33	28	25
	C	3	1.00	150	120	100	86	80	60	48	40	34	30
	C	4	1.15	173	138	115	99	92	69	55	46	39	35
	M	5	1.29	194	155	129	111	103	77	62	52	44	39
	M	6	1.41	212	169	141	121	113	85	68	56	48	42
	M	7	1.53	230	184	153	131	122	92	73	61	52	46
	M	8	1.63	245	196	163	140	130	98	78	65	56	49
03	EC	1.5	0.85	128	102	85	73	68	51	41	34	29	26
	EC	2	0.98	147	118	98	84	78	59	47	39	34	29
	C	3	1.20	180	144	120	103	96	72	58	48	41	36
	C	4	1.39	209	167	139	119	111	83	67	56	48	42
	M	5	1.55	233	186	155	133	124	93	74	62	53	47
	M	6	1.70	255	204	170	146	136	102	82	68	58	51
	M	7	1.83	275	220	183	157	146	110	88	73	63	55
	M	8	1.96	294	235	196	168	157	118	94	78	67	59
04	UC	1.5	1.13	170	136	113	97	90	68	54	45	39	34
	UC	2	1.31	197	157	131	112	105	79	63	52	45	39
	UC	3	1.60	240	192	160	137	128	96	77	64	55	48
	EC	4	1.85	278	222	185	159	148	111	89	74	63	56
	EC	5	2.07	311	248	207	177	166	124	99	83	71	62
	VC	6	2.26	339	271	226	194	181	136	108	90	77	68
	C	7	2.44	366	293	244	209	195	146	117	98	84	73
	C	8	2.61	392	313	261	224	209	157	125	104	89	78

Continued on Next Page

Primary Nozzles

ULTRA-LOW-DRIFT APPLICATION CHART - 50CM NOZZLE SPACING (CONTINUED)

TIP SIZE	ASABE DROPLET SIZE	PRESSURE (BAR)	FLOW RATE (LPM)	APPLICATION RATE L/HA - 50 CM SPACING KM/H									
				8	10	12	14	15	20	25	30	35	40
05	UC	1.5	1.41	212	169	141	121	113	85	68	56	48	42
	UC	2	1.63	245	196	163	140	130	98	78	65	56	49
	EC	3	2.00	300	240	200	171	160	120	96	80	69	60
	EC	4	2.31	347	277	231	198	185	139	111	92	79	69
	VC	5	2.58	387	310	258	221	206	155	124	103	88	77
	VC	6	2.83	425	340	283	243	226	170	136	113	97	85
	C	7	3.06	459	367	306	262	245	184	147	122	105	92
	C	8	3.27	491	392	327	280	262	196	157	131	112	98
06	UC	1.5	1.70	255	204	170	146	136	102	82	68	58	51
	UC	2	1.96	294	235	196	168	157	118	94	78	67	59
	EC	3	2.40	360	288	240	206	192	144	115	96	82	72
	VC	4	2.77	416	332	277	237	222	166	133	111	95	83
	C	5	3.10	465	372	310	266	248	186	149	124	106	93
	C	6	3.39	509	407	339	291	271	203	163	136	116	102
	C	7	3.67	551	440	367	315	294	220	176	147	126	110
	M	8	3.92	588	470	392	336	314	235	188	157	134	118
08	UC	1.5	2.26	339	271	226	194	181	136	108	90	77	68
	EC	2	2.61	392	313	261	224	209	157	125	104	89	78
	VC	3	3.20	480	384	320	274	256	192	154	128	110	96
	C	4	3.70	555	444	370	317	296	222	178	148	127	111
	C	5	4.13	620	496	413	354	330	248	198	165	142	124
	M	6	4.53	680	544	453	388	362	272	217	181	155	136
	M	7	4.89	734	587	489	419	391	293	235	196	168	147
	M	8	5.23	785	628	523	448	418	314	251	209	179	157

Primary Nozzles



3D

The 3D nozzle is an inclined all-purpose nozzle that delivers three-dimensional coverage to overcome the most challenging agronomic/weather conditions while delivering a variety of droplet sizes for different applications. As an enhanced utility nozzle, the 3D nozzle features an integrated fan incline and fan angle designed to maximise efficacy and coverage for application of contact and residual chemistries. By tightening the spray pattern quality to reduce the number small droplets (driftable fines), the 3D can reduce drift potential by up to 50-75 percent (depending on size) compared to a conventional flat-fan nozzle. The 3D is the first flat-fan nozzle to achieve an international drift reduction rating without compromising efficacy*.



- Designed through 10+ years of Syngenta agronomic guidance, field trials, and wind tunnel research
- Agronomic performance proven via Syngenta field research to deliver up to a 10% increase in weed control compared to a conventional flat fan**
- Droplet size and inclined pattern are designed to be installed alternating forwards and backwards on boom to enhance coverage on hard-to-hit targets like grass weeds and complex canopies
- PWM compatible on ExactApply 30Hz high-frequency pulsing
- SnapLock quick-change nozzle assembly includes tip, cap, gasket, and integrated strainer for easy installation

3D 100° spray angle - ASABE droplet size classification chart										
Tip Size		015	02	025	03	035	04	05	06	08
Part Number		PS3DQ00015	PS3DQ0002	PS3DQ00025	PS3DQ0003	PS3DQ00035	PS3DQ0004	PS3DQ0005	PS3DQ0006	PS3DQ0008
Pressure (Bar)	Pressure (PSI)									
0.7	10	C	M	C	VC	VC	XC	XC	XC	XC
1.0	15	M	M	M	C	C	VC	VC	VC	VC
1.4	20	M	M	M	M	C	C	C	C	VC
2.0	30	F	M	M	M	M	M	C	C	C
2.8	40	F	F	M	M	M	M	M	C	C
3.4	50	F	F	F	M	M	M	M	M	M
4.1	60	F	F	F	F	M	M	M	M	M
4.8	70	F	F	F	F	M	M	M	M	M
5.5	80	F	F	F	F	F	M	M	M	M
5.9	85	F	F	F	F	F	F	M	M	M

Droplet data sourced at Pentair Hypro in a steady state condition per ASABE S572.3 Standard.

Features	
Common Use	Contact Herbicide, Plant Health
Pattern	Alternating Tapered Flat Fans
Technology	Advanced Tapered Flat Fan
Material	Polycetal
Spray Angle	100°
Spray Incline	Alternating
Pressure Range	0.7 - 5.9 bar (10-85 PSI)
Configuration	SnapLock Quick Change

Service Parts	
Strainer, 100 mesh (sizes 015-035)	PS311
Strainer, 50 mesh (sizes 04-08)	PS310

Minimum Boom Height	
Nozzle Spacing	Boom Height
38 cm (0.7-1.4 Bar Spray Pressure)	64 cm
50 cm (0.7-1.4 Bar Spray Pressure)	64 cm
38 cm (1.4-5.9 Bar Spray Pressure)	50 cm
50 cm (1.4-5.9 Bar Spray Pressure)	50 cm

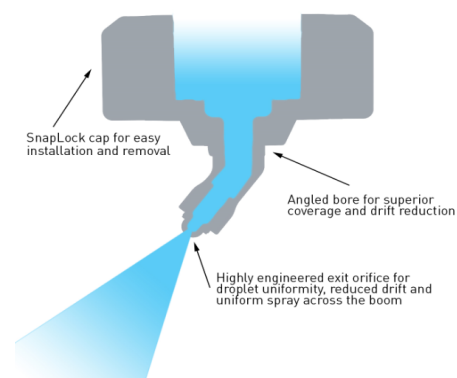

ExactApply™ Compatibility	
15Hz PWM	No
30Hz PWM	Yes
AutoSelect A/B	Yes
Conventional	Yes

*Drift reduction ratings available at <https://secure.pesticides.gov.uk/SprayEquipment/Search.aspx>

**Syngenta UK trials. 0.6l/ha Liberators (diflufenican + flufenacet) + 4l/ha Defy (Prosulfacarb) applied November 2015. Conventional spraying

***Internal supplier testing. John Deere Ultra Low-drift versus 3D. November 2016.

Primary Nozzles

3D APPLICATION CHART - 25CM NOZZLE SPACING

TIP SIZE	ASABE DROPLET SIZE	PRESSURE (BAR)	FLOW RATE (LPM)	APPLICATION RATE L/HA - 25 CM SPACING KM/H									
				8	10	12	14	15	20	25	30	35	40
015	M	1	0.35	104	83	69	59	55	42	33	28	24	21
	M	1.5	0.42	127	102	85	73	68	51	41	34	29	25
	F	2	0.49	147	118	98	84	78	59	47	39	34	29
	F	2.5	0.55	164	131	110	94	88	66	53	44	38	33
	F	3	0.60	180	144	120	103	96	72	58	48	41	36
	F	4	0.69	208	166	139	119	111	83	67	55	48	42
	F	5	0.77	232	186	155	133	124	93	74	62	53	46
	F	6	0.85	255	204	170	145	136	102	81	68	58	51
02	M	1	0.46	139	111	92	79	74	55	44	37	32	28
	M	1.5	0.57	170	136	113	97	91	68	54	45	39	34
	M	2	0.65	196	157	131	112	105	78	63	52	45	39
	F	2.5	0.73	219	175	146	125	117	88	70	58	50	44
	F	3	0.80	240	192	160	137	128	96	77	64	55	48
	F	4	0.92	277	222	185	158	148	111	89	74	63	55
	F	5	1.03	310	248	207	177	165	124	99	83	71	62
	F	6	1.13	339	272	226	194	181	136	109	91	78	68
025	C	1	0.58	173	139	115	99	92	69	55	46	40	35
	M	1.5	0.71	212	170	141	121	113	85	68	57	48	42
	M	2	0.82	245	196	163	140	131	98	78	65	56	49
	M	2.5	0.91	274	219	183	156	146	110	88	73	63	55
	M	3	1.00	300	240	200	171	160	120	96	80	69	60
	M	4	1.15	346	277	231	198	185	139	111	92	79	69
	F	5	1.29	387	310	258	221	207	155	124	103	89	77
	F	6	1.41	424	339	283	242	226	170	136	113	97	85
03	C	1	0.69	208	166	139	119	111	83	67	55	48	42
	M	1.5	0.85	255	204	170	146	136	102	82	68	58	51
	M	2	0.98	294	235	196	168	157	118	94	78	67	59
	M	2.5	1.10	329	263	219	188	175	131	105	88	75	66
	M	3	1.20	360	288	240	206	192	144	115	96	82	72
	F	4	1.39	416	333	277	238	222	166	133	111	95	83
	F	5	1.55	465	372	310	266	248	186	149	124	106	93
	F	6	1.70	509	407	339	291	272	204	163	136	116	102
035	C	1	0.81	242	194	162	139	129	97	78	65	55	48
	M	1.5	0.99	297	238	198	170	158	119	95	79	68	59
	M	2	1.14	343	274	229	196	183	137	110	91	78	69
	M	2.5	1.28	383	307	256	219	204	153	123	102	88	77
	M	3	1.40	420	336	280	240	224	168	134	112	96	84
	M	4	1.62	485	388	323	277	259	194	155	129	111	97
	M	5	1.81	542	434	361	310	289	217	173	145	124	108
	F	6	1.98	594	475	396	339	317	238	190	158	136	119

Continued on Next Page

Primary Nozzles

3D APPLICATION CHART - 25CM NOZZLE SPACING (CONTINUED)

TIP SIZE	ASABE DROPLET SIZE	PRESSURE (BAR)	FLOW RATE (LPM)	APPLICATION RATE L/HA - 25 CM SPACING KM/H									
				8	10	12	14	15	20	25	30	35	40
04	VC	1	0.92	277	222	185	158	148	111	89	74	63	55
	C	1.5	1.13	339	271	226	194	181	136	109	90	78	68
	M	2	1.31	392	313	261	224	209	157	125	104	90	78
	M	2.5	1.46	438	351	292	250	234	175	140	117	100	88
	M	3	1.60	480	384	320	274	256	192	154	128	110	96
	M	4	1.85	554	444	370	317	296	222	177	148	127	111
	M	5	2.07	620	496	413	354	331	248	198	165	142	124
	M	6	2.26	679	543	453	388	362	272	217	181	155	136
05	VC	1	1.16	347	277	231	198	185	139	111	92	79	69
	C	1.5	1.41	424	339	283	242	226	170	136	113	97	85
	M	2	1.63	490	392	327	280	261	196	157	131	112	98
	M	2.5	1.83	548	438	365	313	292	219	175	146	125	110
	M	3	2.00	600	480	400	343	320	240	192	160	137	120
	M	4	2.31	693	554	462	396	369	277	222	185	158	139
	M	5	2.58	775	620	516	443	413	310	248	207	177	155
	M	6	2.83	849	679	566	485	453	339	272	226	194	170
06	VC	1	1.39	416	333	277	238	222	166	133	111	95	83
	C	1.5	1.70	509	407	339	291	272	204	163	136	116	102
	C	2	1.96	588	470	392	336	314	235	188	157	134	118
	C	2.5	2.19	657	526	438	376	351	263	210	175	150	131
	M	3	2.40	720	576	480	411	384	288	230	192	165	144
	M	4	2.77	831	665	554	475	443	333	266	222	190	166
	M	5	3.10	929	744	620	531	496	372	297	248	212	186
	M	6	3.39	1018	815	679	582	543	407	326	272	233	204
08	VC	1	1.85	554	443	370	317	296	222	177	148	127	111
	VC	1.5	2.26	679	543	453	388	362	272	217	181	155	136
	C	2	2.61	784	627	523	448	418	314	251	209	179	157
	C	2.5	2.92	876	701	584	501	467	351	280	234	200	175
	C	3	3.20	960	768	640	549	512	384	307	256	219	192
	C	4	3.70	1109	887	739	633	591	443	355	296	253	222
	C	5	4.13	1239	991	826	708	661	496	397	330	283	248
	C	6	4.53	1358	1086	905	776	724	543	434	362	310	272

Primary Nozzles

3D APPLICATION CHART - 38CM NOZZLE SPACING

TIP SIZE	ASABE DROPLET SIZE	PRESSURE (BAR)	FLOW RATE (LPM)	APPLICATION RATE L/HA - 38 CM SPACING KM/H									
				8	10	12	14	15	20	25	30	35	40
015	M	1	0.35	68	55	46	39	36	27	22	18	16	14
	M	1.5	0.42	84	67	56	48	45	33	27	22	19	17
	F	2	0.49	97	77	64	55	52	39	31	26	22	19
	F	2.5	0.55	108	86	72	62	58	43	35	29	25	22
	F	3	0.60	118	95	79	68	63	47	38	32	27	24
	F	4	0.69	137	109	91	78	73	55	44	36	31	27
	F	5	0.77	153	122	102	87	82	61	49	41	35	31
	F	6	0.85	167	134	112	96	89	67	54	45	38	33
02	M	1	0.46	91	73	61	52	49	36	29	24	21	18
	M	1.5	0.57	112	89	74	64	60	45	36	30	26	22
	M	2	0.65	129	103	86	74	69	52	41	34	29	26
	F	2.5	0.73	144	115	96	82	77	58	46	38	33	29
	F	3	0.80	158	126	105	90	84	63	51	42	36	32
	F	4	0.92	182	146	122	104	97	73	58	49	42	36
	F	5	1.03	204	163	136	116	109	82	65	54	47	41
	F	6	1.13	223	179	149	128	119	89	71	60	51	45
025	C	1	0.58	114	91	76	65	61	46	36	30	26	23
	M	1.5	0.71	140	112	93	80	74	56	45	37	32	28
	M	2	0.82	161	129	107	92	86	64	52	43	37	32
	M	2.5	0.91	180	144	120	103	96	72	58	48	41	36
	M	3	1.00	197	158	132	113	105	79	63	53	45	39
	M	4	1.15	228	182	152	130	122	91	73	61	52	46
	F	5	1.29	255	204	170	146	136	102	82	68	58	51
	F	6	1.41	279	223	186	159	149	112	89	74	64	56
03	C	1	0.69	137	109	91	78	73	55	44	36	31	27
	M	1.5	0.85	168	134	112	96	89	67	54	45	38	34
	M	2	0.98	193	155	129	111	103	77	62	52	44	39
	M	2.5	1.10	216	173	144	123	115	86	69	58	49	43
	M	3	1.20	237	189	158	135	126	95	76	63	54	47
	F	4	1.39	274	219	182	156	146	109	88	73	63	55
	F	5	1.55	306	245	204	175	163	122	98	82	70	61
	F	6	1.70	335	268	223	191	179	134	107	89	77	67
035	C	1	0.81	159	128	106	91	85	64	51	43	36	32
	M	1.5	0.99	195	156	130	112	104	78	63	52	45	39
	M	2	1.14	226	180	150	129	120	90	72	60	52	45
	M	2.5	1.28	252	202	168	144	135	101	81	67	58	50
	M	3	1.40	276	221	184	158	147	111	88	74	63	55
	M	4	1.62	319	255	213	182	170	128	102	85	73	64
	M	5	1.81	357	285	238	204	190	143	114	95	82	71
	F	6	1.98	391	313	261	223	208	156	125	104	89	78

Continued on Next Page

Primary Nozzles

3D APPLICATION CHART - 38CM NOZZLE SPACING (CONTINUED)

TIP SIZE	ASABE DROPLET SIZE	PRESSURE (BAR)	FLOW RATE (LPM)	APPLICATION RATE L/HA - 38 CM SPACING KM/H									
				8	10	12	14	15	20	25	30	35	40
04	VC	1	0.92	182	146	122	104	97	73	58	49	42	36
	C	1.5	1.13	223	179	149	128	119	89	71	60	51	45
	M	2	1.31	258	206	172	147	137	103	82	69	59	52
	M	2.5	1.46	288	231	192	165	154	115	92	77	66	58
	M	3	1.60	316	253	211	180	168	126	101	84	72	63
	M	4	1.85	365	292	243	208	195	146	117	97	83	73
	M	5	2.07	408	326	272	233	217	163	130	109	93	82
	M	6	2.26	447	357	298	255	238	179	143	119	102	89
05	VC	1	1.16	228	182	152	130	122	91	73	61	52	46
	C	1.5	1.41	279	223	186	159	149	112	89	74	64	56
	M	2	1.63	322	258	215	184	172	129	103	86	74	64
	M	2.5	1.83	360	288	240	206	192	144	115	96	82	72
	M	3	2.00	395	316	263	226	211	158	126	105	90	79
	M	4	2.31	456	365	304	260	243	182	146	122	104	91
	M	5	2.58	510	408	340	291	272	204	163	136	116	102
	M	6	2.83	558	447	372	319	298	223	179	149	128	112
06	VC	1	1.39	274	219	182	156	146	109	88	73	63	55
	C	1.5	1.70	335	268	223	191	179	134	107	89	77	67
	C	2	1.96	387	309	258	221	206	155	124	103	88	77
	C	2.5	2.19	432	346	288	247	231	173	138	115	99	86
	M	3	2.40	474	379	316	271	253	189	152	126	108	95
	M	4	2.77	547	438	365	313	292	219	175	146	125	109
	M	5	3.10	611	489	408	349	326	245	196	163	140	122
	M	6	3.39	670	536	447	383	357	268	214	179	153	134
08	VC	1	1.85	365	292	243	208	194	146	117	97	83	73
	VC	1.5	2.26	447	357	298	255	238	179	143	119	102	89
	C	2	2.61	516	413	344	295	275	206	165	138	118	103
	C	2.5	2.92	577	461	384	329	307	231	184	154	132	115
	C	3	3.20	632	505	421	361	337	253	202	168	144	126
	C	4	3.70	729	583	486	417	389	292	233	194	167	146
	C	5	4.13	815	652	544	466	435	326	261	217	186	163
	C	6	4.53	893	715	595	510	476	357	286	238	204	179

Primary Nozzles

3D APPLICATION CHART - 50CM NOZZLE SPACING

TIP SIZE	ASABE DROPLET SIZE	PRESSURE (BAR)	FLOW RATE (LPM)	APPLICATION RATE L/HA - 50 CM SPACING KM/H									
				8	10	12	14	15	20	25	30	35	40
015	M	1	0.35	52	42	35	30	28	21	17	14	12	10
	M	1.5	0.42	64	51	42	36	34	25	20	17	15	13
	F	2	0.49	73	59	49	42	39	29	24	20	17	15
	F	2.5	0.55	82	66	55	47	44	33	26	22	19	16
	F	3	0.60	90	72	60	51	48	36	29	24	21	18
	F	4	0.69	104	83	69	59	55	42	33	28	24	21
	F	5	0.77	116	93	77	66	62	46	37	31	27	23
	F	6	0.85	127	102	85	73	68	51	41	34	29	25
02	M	1	0.46	69	55	46	40	37	28	22	18	16	14
	M	1.5	0.57	85	68	57	48	45	34	27	23	19	17
	M	2	0.65	98	78	65	56	52	39	31	26	22	20
	F	2.5	0.73	110	88	73	63	58	44	35	29	25	22
	F	3	0.80	120	96	80	69	64	48	38	32	27	24
	F	4	0.92	139	111	92	79	74	55	44	37	32	28
	F	5	1.03	155	124	103	89	83	62	50	41	35	31
	F	6	1.13	170	136	113	97	91	68	54	45	39	34
025	C	1	0.58	87	69	58	49	46	35	28	23	20	17
	M	1.5	0.71	106	85	71	61	57	42	34	28	24	21
	M	2	0.82	122	98	82	70	65	49	39	33	28	24
	M	2.5	0.91	137	110	91	78	73	55	44	37	31	27
	M	3	1.00	150	120	100	86	80	60	48	40	34	30
	M	4	1.15	173	139	115	99	92	69	55	46	40	35
	F	5	1.29	194	155	129	111	103	77	62	52	44	39
	F	6	1.41	212	170	141	121	113	85	68	57	48	42
03	C	1	0.69	104	83	69	59	55	42	33	28	24	21
	M	1.5	0.85	127	102	85	73	68	51	41	34	29	25
	M	2	0.98	147	118	98	84	78	59	47	39	34	29
	M	2.5	1.10	164	131	110	94	88	66	53	44	38	33
	M	3	1.20	180	144	120	103	96	72	58	48	41	36
	F	4	1.39	208	166	139	119	111	83	67	55	48	42
	F	5	1.55	232	186	155	133	124	93	74	62	53	46
	F	6	1.70	255	204	170	145	136	102	81	68	58	51
035	C	1	0.81	121	97	81	69	65	48	39	32	28	24
	M	1.5	0.99	149	119	99	85	79	59	48	40	34	30
	M	2	1.14	171	137	114	98	91	69	55	46	39	34
	M	2.5	1.28	192	153	128	110	102	77	61	51	44	38
	M	3	1.40	210	168	140	120	112	84	67	56	48	42
	M	4	1.62	243	194	162	139	129	97	78	65	55	49
	M	5	1.81	271	217	181	155	145	108	87	72	62	54
	F	6	1.98	297	238	198	170	158	119	95	79	68	59

Continued on Next Page

Primary Nozzles

3D APPLICATION CHART - 50CM NOZZLE SPACING (CONTINUED)

TIP SIZE	ASABE DROPLET SIZE	PRESSURE (BAR)	FLOW RATE (LPM)	APPLICATION RATE L/HA - 50 CM SPACING KM/H									
				8	10	12	14	15	20	25	30	35	40
04	VC	1	0.92	139	111	92	79	74	55	44	37	32	28
	C	1.5	1.13	170	136	113	97	90	68	54	45	39	34
	M	2	1.31	196	157	131	112	104	78	63	52	45	39
	M	2.5	1.46	219	175	146	125	117	88	70	58	50	44
	M	3	1.60	240	192	160	137	128	96	77	64	55	48
	M	4	1.85	277	222	185	158	148	111	89	74	63	55
	M	5	2.07	310	248	207	177	165	124	99	83	71	62
	M	6	2.26	339	272	226	194	181	136	109	91	78	68
05	VC	1	1.16	173	139	116	99	92	69	55	46	40	35
	C	1.5	1.41	212	170	141	121	113	85	68	57	48	42
	M	2	1.63	245	196	163	140	131	98	78	65	56	49
	M	2.5	1.83	274	219	183	157	146	110	88	73	63	55
	M	3	2.00	300	240	200	171	160	120	96	80	69	60
	M	4	2.31	346	277	231	198	185	139	111	92	79	69
	M	5	2.58	387	310	258	221	207	155	124	103	89	77
	M	6	2.83	424	339	283	242	226	170	136	113	97	85
06	VC	1	1.39	208	166	139	119	111	83	67	55	48	42
	C	1.5	1.70	255	204	170	145	136	102	81	68	58	51
	C	2	1.96	294	235	196	168	157	118	94	78	67	59
	C	2.5	2.19	329	263	219	188	175	131	105	88	75	66
	M	3	2.40	360	288	240	206	192	144	115	96	82	72
	M	4	2.77	416	333	277	238	222	166	133	111	95	83
	M	5	3.10	465	372	310	266	248	186	149	124	106	93
	M	6	3.39	509	407	339	291	272	204	163	136	116	102
08	VC	1	1.85	277	222	185	158	148	111	89	74	63	55
	VC	1.5	2.26	339	272	226	194	181	136	109	91	78	68
	C	2	2.61	392	314	261	224	209	157	125	105	90	78
	C	2.5	2.92	438	351	292	250	234	175	140	117	100	88
	C	3	3.20	480	384	320	274	256	192	154	128	110	96
	C	4	3.70	554	443	370	317	296	222	177	148	127	111
	C	5	4.13	620	496	413	354	330	248	198	165	142	124
	C	6	4.53	679	543	453	388	362	272	217	181	155	136



Primary Nozzles

LOW-DRIFT MAX (LDM)

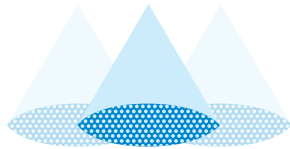

The Low-drift Max (LDM) is ideal for pre- and post-emergence product applications where drift reduction is paramount.

- Dual pre-orifice nozzle designed to reduce drift
- Coarse, Very Coarse and Extremely Coarse droplets for systemic herbicide coverage
- 60° thick pattern for superior coverage
- 120° spray angle for good pattern overlap and prevent pattern collapse at low-percentage flow
- SnapLock quick-change nozzle assembly includes tip, cap, gasket, and integrated strainer for easy installation

Low drift max (LDM) 120 degree spray angle - ASABE droplet size classification chart							
Tip Size		03	04	05	06	08	10
Part Number		PSLDMQ2003	PSLDMQ2004	PSLDMQ2005	PSLDMQ2006	PSLDMQ2008	PSLDMQ2010
Pressure (Bar)	Pressure (PSI)						
1.4	20	XC	XC	XC	N/A	N/A	N/A
2.0	30	VC	VC	XC	XC	XC	XC
2.8	40	VC	VC	VC	XC	XC	VC
3.4	50	VC	C	VC	VC	VC	VC
4.1	60	C	C	VC	VC	VC	VC
4.8	70	C	C	C	C	VC	C
5.5	80	C	C	C	C	C	M

Droplet data sourced at Pentair Hypro in a steady state condition per ASABE S572.3 Standard.

Features	
Common Use	Systemic Herbicide
Pattern	Tapered Flat Fan
Technology	Pre-Orifice
Material	Polyacetal
Spray Angle	120°
Pressure Range	1.4 - 5.5 Bar (20-80 PSI)
Configuration	SnapLock Quick Change

ExactApply™ Compatibility	
15Hz PWM	Yes
30Hz PWM	Yes
AutoSelect A/B	Yes
Conventional	Yes

Minimum Boom Height	
Nozzle Spacing	Boom Height
38cm	38cm
50cm	50cm

Service Parts	
Cap gasket (EPDM)	PM200040-1
Cap gasket (Viton)	PM200040V1

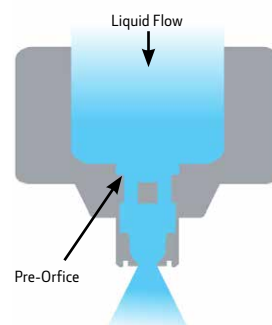

Primary Nozzles

LOW-DRIFT MAX APPLICATION CHART - 25CM NOZZLE SPACING

TIP SIZE	ASABE DROPLET SIZE	PRESSURE (BAR)	FLOW RATE (LPM)	APPLICATION RATE L/HA - 25 CM SPACING KM/H									
				3	4	7	8	10	12	15	20	25	30
03	EC	1.5	0.90	720	540	309	270	216	180	144	108	86	72
	VC	2	1.04	832	624	357	312	250	208	166	125	100	83
	VC	3	1.20	960	720	411	360	288	240	192	144	115	96
	C	4	1.36	1088	816	466	408	326	272	218	163	131	109
	C	5	1.48	1184	888	507	444	355	296	237	178	142	118
	C	6	1.55	1240	930	531	465	372	310	248	186	149	124
04	EC	1.5	1.25	1000	750	429	375	300	250	200	150	120	100
	VC	2	1.40	1120	840	480	420	336	280	224	168	134	112
	C	3	1.60	1280	960	549	480	384	320	256	192	154	128
	C	4	1.80	1440	1080	617	540	432	360	288	216	173	144
	C	5	2.00	1600	1200	686	600	480	400	320	240	192	160
	C	6	2.15	1720	1290	737	645	516	430	344	258	206	172
05	EC	1.5	1.45	1160	870	497	435	348	290	232	174	139	116
	EC	2	1.70	1360	1020	583	510	408	340	272	204	163	136
	VC	3	2.00	1600	1200	686	600	480	400	320	240	192	160
	VC	4	2.27	1816	1362	778	681	545	454	363	272	218	182
	C	5	2.48	1984	1488	850	744	595	496	397	298	238	198
	C	6	2.68	2144	1608	919	804	643	536	429	322	257	214
06	EC	1.5	1.85	1480	1110	634	555	444	370	296	222	178	148
	EC	2	2.10	1680	1260	720	630	504	420	336	252	202	168
	EC	3	2.40	1920	1440	823	720	576	480	384	288	230	192
	VC	4	2.70	2160	1620	926	810	648	540	432	324	259	216
	VC	5	2.95	2360	1770	1011	885	708	590	472	354	283	236
	C	6	3.20	2560	1920	1097	960	768	640	512	384	307	256
08	EC	1.5	2.50	2000	1500	857	750	600	500	400	300	240	200
	EC	2	2.78	2224	1668	953	834	667	556	445	334	267	222
	EC	3	3.20	2560	1920	1097	960	768	640	512	384	307	256
	EC	4	3.60	2880	2160	1234	1080	864	720	576	432	346	288
	VC	5	3.95	3160	2370	1354	1185	948	790	632	474	379	316
	C	6	4.30	3440	2580	1474	1290	1032	860	688	516	413	344
10	EC	1.5	3.25	2600	1950	1114	975	780	650	520	390	312	260
	EC	2	3.60	2880	2160	1234	1080	864	720	576	432	346	288
	VC	3	4.00	3200	2400	1371	1200	960	800	640	480	384	320
	VC	4	4.75	3800	2850	1629	1425	1140	950	760	570	456	380
	C	5	5.20	4160	3120	1783	1560	1248	1040	832	624	499	416
	C	6	5.65	4520	3390	1937	1695	1356	1130	904	678	542	452

Primary Nozzles

LOW-DRIFT MAX APPLICATION CHART - 38CM NOZZLE SPACING

TIP SIZE	ASABE DROPLET SIZE	PRESSURE (BAR)	FLOW RATE (LPM)	APPLICATION RATE L/HA - 38 CM SPACING KM/H									
				3	4	7	8	10	12	15	20	25	30
03	EC	1.5	0.90	474	355	203	178	142	118	95	71	57	47
	VC	2	1.04	547	411	235	205	164	137	109	82	66	55
	VC	3	1.20	632	474	271	237	189	158	126	95	76	63
	C	4	1.36	716	537	307	268	215	179	143	107	86	72
	C	5	1.48	779	584	334	292	234	195	156	117	93	78
	C	6	1.55	816	612	350	306	245	204	163	122	98	82
04	EC	1.5	1.25	658	493	282	247	197	164	132	99	79	66
	VC	2	1.40	737	553	316	276	221	184	147	111	88	74
	C	3	1.60	842	632	361	316	253	211	168	126	101	84
	C	4	1.80	947	711	406	355	284	237	189	142	114	95
	C	5	2.00	1053	789	451	395	316	263	211	158	126	105
	C	6	2.15	1132	849	485	424	339	283	226	170	136	113
05	EC	1.5	1.45	763	572	327	286	229	191	153	114	92	76
	EC	2	1.70	895	671	383	336	268	224	179	134	107	89
	VC	3	2.00	1053	789	451	395	316	263	211	158	126	105
	VC	4	2.27	1195	896	512	448	358	299	239	179	143	119
	C	5	2.48	1305	979	559	489	392	326	261	196	157	131
	C	6	2.68	1411	1058	605	529	423	353	282	212	169	141
06	EC	1.5	1.85	974	730	417	365	292	243	195	146	117	97
	EC	2	2.10	1105	829	474	414	332	276	221	166	133	111
	EC	3	2.40	1263	947	541	474	379	316	253	189	152	126
	VC	4	2.70	1421	1066	609	533	426	355	284	213	171	142
	VC	5	2.95	1553	1164	665	582	466	388	311	233	186	155
	C	6	3.20	1684	1263	722	632	505	421	337	253	202	168
08	EC	1.5	2.50	1316	987	564	493	395	329	263	197	158	132
	EC	2	2.78	1463	1097	627	549	439	366	293	219	176	146
	EC	3	3.20	1684	1263	722	632	505	421	337	253	202	168
	EC	4	3.60	1895	1421	812	711	568	474	379	284	227	189
	VC	5	3.95	2079	1559	891	780	624	520	416	312	249	208
	C	6	4.30	2263	1697	970	849	679	566	453	339	272	226
10	EC	1.5	3.25	1711	1283	733	641	513	428	342	257	205	171
	EC	2	3.60	1895	1421	812	711	568	474	379	284	227	189
	VC	3	4.00	2105	1579	902	789	632	526	421	316	253	211
	VC	4	4.75	2500	1875	1071	938	750	625	500	375	300	250
	C	5	5.20	2737	2053	1173	1026	821	684	547	411	328	274
	C	6	5.65	2974	2230	1274	1115	892	743	595	446	357	297

Primary Nozzles

LOW-DRIFT MAX APPLICATION CHART - 50CM NOZZLE SPACING

TIP SIZE	ASABE DROPLET SIZE	PRESSURE (BAR)	FLOW RATE (LPM)	APPLICATION RATE L/HA - 50 CM SPACING KM/H									
				3	4	7	8	10	12	15	20	25	30
03	EC	1.5	0.90	360	270	154	135	108	90	72	54	43	36
	VC	2	1.04	416	312	178	156	125	104	83	62	50	42
	VC	3	1.20	480	360	206	180	144	120	96	72	58	48
	C	4	1.36	544	408	233	204	163	136	109	82	65	54
	C	5	1.48	592	444	254	222	178	148	118	89	71	59
	C	6	1.55	620	465	266	233	186	155	124	93	74	62
04	EC	1.5	1.25	500	375	214	188	150	125	100	75	60	50
	VC	2	1.40	560	420	240	210	168	140	112	84	67	56
	C	3	1.60	640	480	274	240	192	160	128	96	77	64
	C	4	1.80	720	540	309	270	216	180	144	108	86	72
	C	5	2.00	800	600	343	300	240	200	160	120	96	80
	C	6	2.15	860	645	369	323	258	215	172	129	103	86
05	EC	1.5	1.45	580	435	249	217.5	174	145	116	87	70	58
	EC	2	1.70	680	510	291	255	204	170	136	102	82	68
	VC	3	2.00	800	600	343	300	240	200	160	120	96	80
	VC	4	2.27	908	681	389	341	272	227	182	136	109	91
	C	5	2.48	992	744	425	372	298	248	198	149	119	99
	C	6	2.68	1072	804	459	402	322	268	214	161	129	107
06	EC	1.5	1.85	740	555	317	278	222	185	148	111	89	74
	EC	2	2.10	840	630	360	315	252	210	168	126	101	84
	EC	3	2.40	960	720	411	360	288	240	192	144	115	96
	VC	4	2.70	1080	810	463	405	324	270	216	162	130	108
	VC	5	2.95	1180	885	506	443	354	295	236	177	142	118
	C	6	3.20	1280	960	549	480	384	320	256	192	154	128
08	EC	1.5	2.50	1000	750	429	375	300	250	200	150	120	100
	EC	2	2.78	1112	834	477	417	334	278	222	167	133	111
	EC	3	3.20	1280	960	549	480	384	320	256	192	154	128
	EC	4	3.60	1440	1080	617	540	432	360	288	216	173	144
	VC	5	3.95	1580	1185	677	593	474	395	316	237	190	158
	C	6	4.30	1720	1290	737	645	516	430	344	258	206	172
10	EC	1.5	3.25	1300	975	557	488	390	325	260	195	156	130
	EC	2	3.60	1440	1080	617	540	432	360	288	216	173	144
	VC	3	4.00	1600	1200	686	600	480	400	320	240	192	160
	VC	4	4.75	1900	1425	814	713	570	475	380	285	228	190
	C	5	5.20	2080	1560	891	780	624	520	416	312	250	208
	C	6	5.65	2260	1695	969	848	678	565	452	339	271	226



Primary Nozzles

LOW-DRIFT TWIN (LDT)

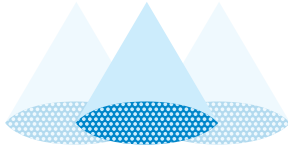

The Low-drift Twin nozzle offers superior coverage for customers who are pulsing and want dual 30° incline sprays in one nozzle. The LDT provides a wide operating range and wide size selections to work with PWM to meet any speed/rate need required.

- Twin 30° forward- and rear-facing dual angles for superior coverage
- Medium and Coarse droplets for fungicides, insecticides and contact herbicides
- SnapLock quick-change nozzle assembly includes tip, cap, gasket, and integrated strainer for easy installation

Low-drift Twin (LDT) 110° spray angle - ASABE droplet size classification chart

Tip Size		03	04	05	06	08	10	12	16
Part Number		PSLDTQ1003	PSLDTQ1004	PSLDTQ1005	PSLDTQ1006	PSLDTQ1008	PSLDTQ1010	PSLDTQ1012	PSLDTQ1016
Pressure (PSI)									
1.0	15	M	C	C	C	C	C	VC	VC
1.4	20	M	M	M	C	C	C	VC	VC
2.0	30	M	M	M	C	C	C	C	C
2.8	40	M	M	M	M	M	C	C	C
3.4	50	M	M	M	M	M	C	C	C
4.1	60	M	M	M	M	M	M	C	C
4.8	70	F	M	M	M	M	M	M	C

Droplet data sourced at Pentair Hypro in a steady state condition per ASABE S572.3 Standard.

Features	
Common Use	Plant Health
Pattern	Twin Incline Tapered Flat Fans
Technology	Pre-Orifice
Material	Polyacetal
Spray Angle	110°
Pressure Range	1 - 4.8 Bar (15-70 PSI)
Configuration	SnapLock Quick Change

ExactApply™ Compatibility	
15Hz PWM	Yes
30Hz PWM	Yes
AutoSelect A/B	Yes
Conventional	Yes

Minimum Boom Height	
Nozzle Spacing	Boom Height
38cm	38cm
50cm	50cm

Service Parts	
Strainer (50 mesh)	PS0250

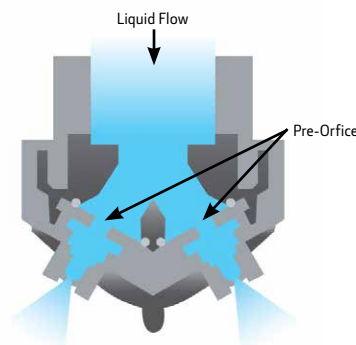

Primary Nozzles

LOW-DRIFT TWIN APPLICATION CHART - 25CM NOZZLE SPACING

TIP SIZE	ASABE DROPLET SIZE	PRESSURE (BAR)	FLOW RATE (LPM)	APPLICATION RATE L/HA - 25 CM SPACING KM/H									
				8	10	12	14	15	20	25	30	35	40
03	S	1.5	0.69	208	166	139	119	111	83	67	55	48	42
	S	2	0.80	241	193	161	138	128	96	77	64	55	48
	S	3	1.14	341	273	227	195	182	136	109	91	78	68
	S	4	1.27	381	305	254	218	203	152	122	102	87	76
	S	5	1.39	417	334	278	238	223	167	134	111	95	83
	S	6	1.50	451	361	300	258	240	180	144	120	103	90
04	S	1.5	0.92	277	222	185	158	148	111	89	74	63	55
	S	2	1.07	321	257	214	184	171	128	103	86	73	64
	S	3	1.51	454	363	303	260	242	182	145	121	104	91
	S	4	1.69	508	406	339	290	271	203	163	135	116	102
	S	5	1.85	556	445	371	318	297	223	178	148	127	111
	S	6	2.00	601	481	401	343	320	240	192	160	137	120
05	S	1.5	1.16	347	277	231	198	185	139	111	92	79	69
	S	2	1.34	402	321	268	229	214	161	128	107	92	80
	S	3	1.89	568	454	379	324	303	227	182	151	130	114
	S	4	2.12	635	508	423	363	339	254	203	169	145	127
	S	5	2.32	695	556	464	397	371	278	223	185	159	139
	S	6	2.50	751	601	501	429	401	300	240	200	172	150
06	S	1.5	1.39	416	333	277	238	222	166	133	111	95	83
	S	2	1.61	482	385	321	275	257	193	154	128	110	96
	S	3	2.27	681	545	454	389	363	273	218	182	156	136
	S	4	2.54	762	609	508	435	406	305	244	203	174	152
	S	5	2.78	835	668	556	477	445	334	267	223	191	167
	S	6	3.00	901	721	601	515	481	361	288	240	206	180
08	S	1.5	1.85	554	443	370	317	296	222	177	148	127	111
	S	2	2.14	642	514	428	367	343	257	206	171	147	128
	S	3	3.03	908	727	606	519	485	363	291	242	208	182
	S	4	3.39	1016	813	677	580	542	406	325	271	232	203
	S	5	3.71	1113	890	742	636	593	445	356	297	254	223
	S	6	4.01	1202	961	801	687	641	481	385	320	275	240
10	S	1.5	2.32	695	556	464	397	371	278	223	185	159	139
	S	2	2.68	803	642	535	459	428	321	257	214	184	161
	S	3	3.79	1136	908	757	649	606	454	363	303	260	227
	S	4	4.23	1270	1016	846	726	677	508	406	339	290	254
	S	5	4.64	1391	1113	927	795	742	556	445	371	318	278
	S	6	5.01	1502	1202	1002	858	801	601	481	401	343	300
12	VC	1.5	2.78	835	668	556	477	445	334	267	223	191	167
	VC	2	3.21	964	771	642	551	514	385	308	257	220	193
	C	3	4.54	1363	1090	908	779	727	545	436	363	311	273
	C	4	5.08	1524	1219	1016	871	813	609	488	406	348	305
	C	5	5.56	1669	1335	1113	954	890	668	534	445	381	334
	M	6	6.01	1803	1442	1202	1030	961	721	577	481	412	361
16	VC	1.5	3.71	1113	890	742	636	593	445	356	297	254	223
	VC	2	4.28	1285	1028	857	734	685	514	411	343	294	257
	C	3	6.06	1817	1454	1211	1038	969	727	581	485	415	363
	C	4	6.77	2031	1625	1354	1161	1083	813	650	542	464	406
	C	5	7.42	2225	1780	1484	1272	1187	890	712	593	509	445
	C	6	8.01	2404	1923	1602	1374	1282	961	769	641	549	481

Primary Nozzles

LOW-DRIFT TWIN APPLICATION CHART - 38CM NOZZLE SPACING

TIP SIZE	ASABE DROPLET SIZE	PRESSURE (BAR)	FLOW RATE (LPM)	APPLICATION RATE L/HA - 38 CM SPACING KM/H									
				8	10	12	14	15	20	25	30	35	40
03	M	1.5	0.69	137	109	91	78	73	55	44	36	31	27
	M	2	0.80	158	127	106	91	85	63	51	42	36	32
	F	3	1.14	224	179	149	128	120	90	72	60	51	45
	F	4	1.27	251	200	167	143	134	100	80	67	57	50
	F	5	1.39	275	220	183	157	146	110	88	73	63	55
	F	6	1.50	297	237	198	169	158	119	95	79	68	59
04	M	1.5	0.92	182	146	122	104	97	73	58	49	42	36
	M	2	1.07	211	169	141	121	113	85	68	56	48	42
	M	3	1.51	299	239	199	171	159	120	96	80	68	60
	F	4	1.69	334	267	223	191	178	134	107	89	76	67
	F	5	1.85	366	293	244	209	195	146	117	98	84	73
	F	6	2.00	395	316	264	226	211	158	127	105	90	79
05	M	1.5	1.16	228	182	152	130	122	91	73	61	52	46
	M	2	1.34	264	211	176	151	141	106	85	70	60	53
	M	3	1.89	374	299	249	213	199	149	120	100	85	75
	F	4	2.12	418	334	278	239	223	167	134	111	95	84
	F	5	2.32	458	366	305	261	244	183	146	122	105	92
	F	6	2.50	494	395	329	282	264	198	158	132	113	99
06	C	1.5	1.39	274	219	182	156	146	109	88	73	63	55
	M	2	1.61	317	254	211	181	169	127	101	85	72	63
	M	3	2.27	448	359	299	256	239	179	143	120	102	90
	M	4	2.54	501	401	334	286	267	200	160	134	115	100
	F	5	2.78	549	439	366	314	293	220	176	146	125	110
	F	6	3.00	593	474	395	339	316	237	190	158	136	119
08	C	1.5	1.85	365	292	243	208	194	146	117	97	83	73
	C	2	2.14	423	338	282	242	225	169	135	113	97	85
	M	3	3.03	598	478	398	342	319	239	191	159	137	120
	M	4	3.39	668	535	445	382	356	267	214	178	153	134
	M	5	3.71	732	586	488	418	390	293	234	195	167	146
	F	6	4.01	791	633	527	452	422	316	253	211	181	158
10	C	1.5	2.32	458	366	305	261	244	183	146	122	105	92
	C	2	2.68	528	423	352	302	282	211	169	141	121	106
	M	3	3.79	747	598	498	427	398	299	239	199	171	149
	M	4	4.23	835	668	557	477	445	334	267	223	191	167
	M	5	4.64	915	732	610	523	488	366	293	244	209	183
	F	6	5.01	988	791	659	565	527	395	316	264	226	198
12	VC	1.5	2.78	549	439	366	314	293	220	176	146	125	110
	VC	2	3.21	634	507	423	362	338	254	203	169	145	127
	C	3	4.54	897	717	598	512	478	359	287	239	205	179
	C	4	5.08	1002	802	668	573	535	401	321	267	229	200
	C	5	5.56	1098	878	732	627	586	439	351	293	251	220
	M	6	6.01	1186	949	791	678	633	474	380	316	271	237
16	VC	1.5	3.71	732	586	488	418	390	293	234	195	167	146
	VC	2	4.28	845	676	564	483	451	338	270	225	193	169
	C	3	6.06	1195	956	797	683	638	478	383	319	273	239
	C	4	6.77	1336	1069	891	764	713	535	428	356	305	267
	C	5	7.42	1464	1171	976	837	781	586	468	390	335	293
	C	6	8.01	1581	1265	1054	904	843	633	506	422	361	316

Primary Nozzles

LOW-DRIFT TWIN APPLICATION CHART - 50CM NOZZLE SPACING

TIP SIZE	ASABE DROPLET SIZE	PRESSURE (BAR)	FLOW RATE (LPM)	APPLICATION RATE L/HA - 50 CM SPACING KM/H									
				8	10	12	14	15	20	25	30	35	40
03	M	1.5	0.69	104	83	69	59	55	42	33	28	24	21
	M	2	0.80	120	96	80	69	64	48	39	32	28	24
	F	3	1.14	170	136	114	97	91	68	55	45	39	34
	F	4	1.27	190	152	127	109	102	76	61	51	44	38
	F	5	1.39	209	167	139	119	111	83	67	56	48	42
	F	6	1.50	225	180	150	129	120	90	72	60	52	45
04	M	1.5	0.92	139	111	92	79	74	55	44	37	32	28
	M	2	1.07	161	128	107	92	86	64	51	43	37	32
	M	3	1.51	227	182	151	130	121	91	73	61	52	45
	F	4	1.69	254	203	169	145	135	102	81	68	58	51
	F	5	1.85	278	223	185	159	148	111	89	74	64	56
	F	6	2.00	300	240	200	172	160	120	96	80	69	60
05	M	1.5	1.16	173	139	116	99	92	69	55	46	40	35
	M	2	1.34	201	161	134	115	107	80	64	54	46	40
	M	3	1.89	284	227	189	162	151	114	91	76	65	57
	F	4	2.12	317	254	212	181	169	127	102	85	73	63
	F	5	2.32	348	278	232	199	185	139	111	93	79	70
	F	6	2.50	376	300	250	215	200	150	120	100	86	75
06	C	1.5	1.39	208	166	139	119	111	83	67	55	48	42
	M	2	1.61	241	193	161	138	128	96	77	64	55	48
	M	3	2.27	341	273	227	195	182	136	109	91	78	68
	M	4	2.54	381	305	254	218	203	152	122	102	87	76
	F	5	2.78	417	334	278	238	223	167	134	111	95	83
	F	6	3.00	451	361	300	258	240	180	144	120	103	90
08	C	1.5	1.85	277	222	185	158	148	111	89	74	63	55
	C	2	2.14	321	257	214	184	171	128	103	86	73	64
	M	3	3.03	454	363	303	260	242	182	145	121	104	91
	M	4	3.39	508	406	339	290	271	203	163	135	116	102
	M	5	3.71	556	445	371	318	297	223	178	148	127	111
	F	6	4.01	601	481	401	343	320	240	192	160	137	120
10	C	1.5	2.32	348	278	232	199	185	139	111	93	79	70
	C	2	2.68	402	321	268	229	214	161	128	107	92	80
	M	3	3.79	568	454	379	324	303	227	182	151	130	114
	M	4	4.23	635	508	423	363	339	254	203	169	145	127
	M	5	4.64	695	556	464	397	371	278	223	185	159	139
	F	6	5.01	751	601	501	429	401	300	240	200	172	150
12	VC	1.5	2.78	417	334	278	238	223	167	134	111	95	83
	VC	2	3.21	482	385	321	275	257	193	154	128	110	96
	C	3	4.54	681	545	454	389	363	273	218	182	156	136
	C	4	5.08	762	609	508	435	406	305	244	203	174	152
	C	5	5.56	835	668	556	477	445	334	267	223	191	167
	M	6	6.01	901	721	601	515	481	361	288	240	206	180
16	VC	1.5	3.71	556	445	371	318	297	223	178	148	127	111
	VC	2	4.28	642	514	428	367	343	257	206	171	147	128
	C	3	6.06	908	727	606	519	485	363	291	242	208	182
	C	4	6.77	1016	813	677	580	542	406	325	271	232	203
	C	5	7.42	1113	890	742	636	593	445	356	297	254	223
	C	6	8.01	1202	961	801	687	641	481	385	320	275	240



Primary Nozzles

ULTRA-LOW-DRIFT MAX (ULDM) 130°



The Ultra-low-drift Max nozzle is ideal nozzle for post-emergence herbicide applications where drift reduction is paramount. It is perfect for dicamba herbicide applications. Check chemical labels for latest EPA approvals.

- 130° spray angle allows boom height to be lowered and prevents pattern collapse when used with drift reduction adjuvants
- Air-induction technology creates air-filled droplets to significantly reduce drift potential
- SnapLock quick-change nozzle assembly includes tip, cap, gasket, and integrated strainer for easy installation

Ultra Low-drift Max (ULD Max) 130° spray angle - ASABE droplet size classification chart								
Tip size		02	025	03	04	05	06	08
Part Number		PSULDMQ3002	PSULDMQ30025	PSULDMQ3003	PSULDMQ3004	PSULDMQ3005	PSULDMQ3006	PSULDMQ3008
Pressure (Bar)	Pressure (PSI)							
2.0	30	UC	UC	UC	UC	UC	UC	UC
2.8	40	UC	UC	UC	UC	UC	UC	UC
3.4	50	UC	UC	UC	UC	UC	UC	UC
4.1	60	UC	UC	XC	UC	UC	UC	UC
4.8	70	XC	UC	XC	UC	UC	UC	UC
5.5	80	XC	UC	XC	UC	UC	UC	UC
6.2	90	XC	XC	XC	UC	UC	UC	XC
6.9	100	XC	XC	XC	XC	XC	XC	XC

Droplet data sourced at Pentair Hypro in a steady state condition per ASABE S572.3 Standard.

Features	
Common Use	Systemic Herbicide
Pattern	Tapered Flat Fan
Technology	Air Induction
Material	Polyacetal
Spray Angle	130°
Pressure Range	2-7 Bar (30-100 PSI)
Configuration	SnapLock Quick Change

ExactApply™ Compatibility	
15 Hz PWM	Yes
30 Hz PWM	Yes
AutoSelect A/B	Yes
Conventional	Yes

Service Parts	
Cap gasket	PS22700150
Strainer (50 mesh)	PS0250

Minimum Boom Height	
Nozzle spacing	Boom height
38cm	30cm
50cm	40cm

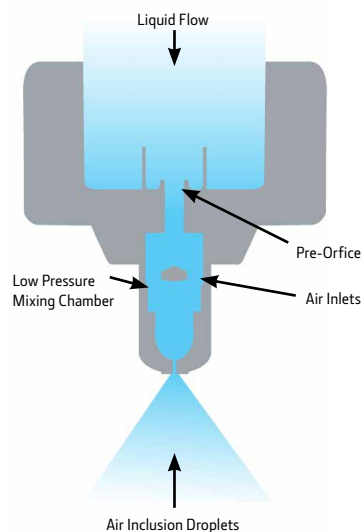

Primary Nozzles

ULTRA-LOW-DRIFT MAX APPLICATION CHART - 25CM NOZZLE SPACING

TIP SIZE	ASABE DROPLET SIZE	PRESSURE (BAR)	FLOW RATE (LPM)	APPLICATION RATE L/HA - 25 CM SPACING KM/H									
				8	10	12	14	15	20	25	30	35	40
02	UC	2	0.64	192	154	128	110	102	77	61	51	44	38
	UC	3	0.80	240	192	160	137	128	96	77	64	55	48
	UC	4	0.91	273	218	182	156	146	109	87	73	62	55
	EC	5	1.03	309	247	206	177	165	124	99	82	71	62
	EC	6	1.13	339	271	226	194	181	136	108	90	77	68
	EC	7	1.22	366	293	244	209	195	146	117	98	84	73
025	UC	2	0.83	249	199	166	142	133	100	80	66	57	50
	UC	3	1.00	300	240	200	171	160	120	96	80	69	60
	UC	4	1.15	345	276	230	197	184	138	110	92	79	69
	EC	5	1.29	387	310	258	221	206	155	124	103	88	77
	EC	6	1.41	423	338	282	242	226	169	135	113	97	85
	EC	7	1.53	459	367	306	262	245	184	147	122	105	92
03	UC	2	0.98	294	235	196	168	157	118	94	78	67	59
	UC	3	1.20	360	288	240	206	192	144	115	96	82	72
	UC	4	1.40	420	336	280	240	224	168	134	112	96	84
	UC	5	1.55	465	372	310	266	248	186	149	124	106	93
	EC	6	1.70	510	408	340	291	272	204	163	136	117	102
	EC	7	1.83	549	439	366	314	293	220	176	146	125	110
04	UC	2	1.32	396	317	264	226	211	158	127	106	91	79
	UC	3	1.60	480	384	320	274	256	192	154	128	110	96
	UC	4	1.85	555	444	370	317	296	222	178	148	127	111
	UC	5	2.07	621	497	414	355	331	248	199	166	142	124
	UC	6	2.26	678	542	452	387	362	271	217	181	155	136
	UC	7	2.44	732	586	488	418	390	293	234	195	167	146
05	UC	2	1.63	489	391	326	279	261	196	156	130	112	98
	UC	3	2.00	600	480	400	343	320	240	192	160	137	120
	UC	4	2.31	693	554	462	396	370	277	222	185	158	139
	UC	5	2.58	774	619	516	442	413	310	248	206	177	155
	UC	6	2.83	849	679	566	485	453	340	272	226	194	170
	UC	7	3.06	918	734	612	525	490	367	294	245	210	184
06	UC	2	1.97	591	473	394	338	315	236	189	158	135	118
	UC	3	2.40	720	576	480	411	384	288	230	192	165	144
	UC	4	2.76	828	662	552	473	442	331	265	221	189	166
	UC	5	3.10	930	744	620	531	496	372	298	248	213	186
	UC	6	3.39	1017	814	678	581	542	407	325	271	232	203
	UC	7	3.67	1101	881	734	629	587	440	352	294	252	220
08	UC	2	2.61	783	626	522	447	418	313	251	209	179	157
	UC	3	3.20	960	768	640	549	512	384	307	256	219	192
	UC	4	3.71	1113	890	742	636	594	445	356	297	254	223
	UC	5	4.13	1239	991	826	708	661	496	396	330	283	248
	UC	6	4.53	1359	1087	906	777	725	544	435	362	311	272
	EC	7	4.89	1467	1174	978	838	782	587	469	391	335	293

Primary Nozzles

ULTRA-LOW-DRIFT MAX APPLICATION CHART - 38CM NOZZLE SPACING

TIP SIZE	ASABE DROPLET SIZE	PRESSURE (BAR)	FLOW RATE (LPM)	APPLICATION RATE L/HA - 38 CM SPACING KM/H									
				8	10	12	14	15	20	25	30	35	40
02	UC	2	0.64	126	101	84	72	67	51	40	34	29	25
	UC	3	0.80	158	126	105	90	84	63	51	42	36	32
	UC	4	0.91	180	144	120	103	96	72	57	48	41	36
	EC	5	1.03	203	163	136	116	108	81	65	54	46	41
	EC	6	1.13	223	178	149	127	119	89	71	59	51	45
	EC	7	1.22	241	193	161	138	128	96	77	64	55	48
025	UC	2	0.83	164	131	109	94	87	66	52	44	37	33
	UC	3	1.00	197	158	132	113	105	79	63	53	45	39
	UC	4	1.15	227	182	151	130	121	91	73	61	52	45
	EC	5	1.29	255	204	170	145	136	102	81	68	58	51
	EC	6	1.41	278	223	186	159	148	111	89	74	64	56
	EC	7	1.53	302	242	201	173	161	121	97	81	69	60
03	UC	2	0.98	193	155	129	111	103	77	62	52	44	39
	UC	3	1.20	237	189	158	135	126	95	76	63	54	47
	UC	4	1.40	276	221	184	158	147	111	88	74	63	55
	UC	5	1.55	306	245	204	175	163	122	98	82	70	61
	EC	6	1.70	336	268	224	192	179	134	107	89	77	67
	EC	7	1.83	361	289	241	206	193	144	116	96	83	72
04	UC	2	1.32	261	208	174	149	139	104	83	69	60	52
	UC	3	1.60	316	253	211	180	168	126	101	84	72	63
	UC	4	1.85	365	292	243	209	195	146	117	97	83	73
	UC	5	2.07	409	327	272	233	218	163	131	109	93	82
	UC	6	2.26	446	357	297	255	238	178	143	119	102	89
	UC	7	2.44	482	385	321	275	257	193	154	128	110	96
05	UC	2	1.63	322	257	214	184	172	129	103	86	74	64
	UC	3	2.00	395	316	263	226	211	158	126	105	90	79
	UC	4	2.31	456	365	304	261	243	182	146	122	104	91
	UC	5	2.58	509	407	339	291	272	204	163	136	116	102
	UC	6	2.83	559	447	372	319	298	223	179	149	128	112
	UC	7	3.06	604	483	403	345	322	242	193	161	138	121
06	UC	2	1.97	389	311	259	222	207	156	124	104	89	78
	UC	3	2.40	474	379	316	271	253	189	152	126	108	95
	UC	4	2.76	545	436	363	311	291	218	174	145	125	109
	UC	5	3.10	612	489	408	350	326	245	196	163	140	122
	UC	6	3.39	669	535	446	382	357	268	214	178	153	134
	UC	7	3.67	724	579	483	414	386	290	232	193	166	145
08	UC	2	2.61	515	412	343	294	275	206	165	137	118	103
	UC	3	3.20	632	505	421	361	337	253	202	168	144	126
	UC	4	3.71	732	586	488	418	391	293	234	195	167	146
	UC	5	4.13	815	652	543	466	435	326	261	217	186	163
	UC	6	4.53	894	715	596	511	477	358	286	238	204	179
	EC	7	4.89	965	772	643	552	515	386	309	257	221	193

Primary Nozzles

ULTRA-LOW-DRIFT MAX APPLICATION CHART - 50CM NOZZLE SPACING

TIP SIZE	ASABE DROPLET SIZE	PRESSURE (BAR)	FLOW RATE (LPM)	APPLICATION RATE L/HA - 50 CM SPACING KM/H									
				8	10	12	14	15	20	25	30	35	40
02	UC	2	0.64	96	76.8	64	55	51	38.4	31	26	22	19
	UC	3	0.80	120	96	80	69	64	48	38	32	27	24
	UC	4	0.91	136.5	109.2	91	78	73	54.6	44	36	31	27
	EC	5	1.03	154.5	123.6	103	88	82	61.8	49	41	35	31
	EC	6	1.13	169.5	135.6	113	97	90	67.8	54	45	39	34
	EC	7	1.22	183	146.4	122	105	98	73.2	59	49	42	37
025	UC	2	0.83	124.5	99.6	83	71	66	49.8	40	33	28	25
	UC	3	1.00	150	120	100	86	80	60	48	40	34	30
	UC	4	1.15	172.5	138	115	99	92	69	55	46	39	35
	EC	5	1.29	193.5	154.8	129	111	103	77.4	62	52	44	39
	EC	6	1.41	211.5	169.2	141	121	113	84.6	68	56	48	42
	EC	7	1.53	229.5	183.6	153	131	122	91.8	73	61	52	46
03	UC	2	0.98	147	117.6	98	84	78	58.8	47	39	34	29
	UC	3	1.20	180	144	120	102.857	96	72	58	48	41	36
	UC	4	1.40	210	168	140	120	112	84	67	56	48	42
	UC	5	1.55	232.5	186	155	133	124	93	74	62	53	47
	EC	6	1.70	255	204	170	146	136	102	82	68	58	51
	EC	7	1.83	274.5	219.6	183	157	146	109.8	88	73	63	55
04	UC	2	1.32	198	158.4	132	113	106	79.2	63	53	45	40
	UC	3	1.60	240	192	160	137	128	96	77	64	55	48
	UC	4	1.85	277.5	222	185	159	148	111	89	74	63	56
	UC	5	2.07	310.5	248.4	207	177	166	124.2	99	83	71	62
	UC	6	2.26	339	271.2	226	194	181	135.6	108	90	77	68
	UC	7	2.44	366	292.8	244	209	195	146.4	117	98	84	73
05	UC	2	1.63	244.5	195.6	163	140	130	97.8	78	65	56	49
	UC	3	2.00	300	240	200	171	160	120	96	80	69	60
	UC	4	2.31	346.5	277.2	231	198	185	138.6	111	92	79	69
	UC	5	2.58	387	309.6	258	221	206	154.8	124	103	88	77
	UC	6	2.83	424.5	339.6	283	243	226	169.8	136	113	97	85
	UC	7	3.06	459	367.2	306	262	245	183.6	147	122	105	92
06	UC	2	1.97	295.5	236.4	197	169	158	118.2	95	79	68	59
	UC	3	2.40	360	288	240	206	192	144	115	96	82	72
	UC	4	2.76	414	331.2	276	237	221	165.6	132	110	95	83
	UC	5	3.10	465	372	310	266	248	186	149	124	106	93
	UC	6	3.39	508.5	406.8	339	291	271	203.4	163	136	116	102
	UC	7	3.67	550.5	440.4	367	315	294	220.2	176	147	126	110
08	UC	2	2.61	391.5	313.2	261	224	209	156.6	125	104	89	78
	UC	3	3.20	480	384	320	274	256	192	154	128	110	96
	UC	4	3.71	556.5	445.2	371	318	297	222.6	178	148	127	111
	UC	5	4.13	619.5	495.6	413	354	330	247.8	198	165	142	124
	UC	6	4.53	679.5	543.6	453	388	362	271.8	217	181	155	136
	EC	7	4.89	733.5	586.8	489	419	391	293.4	235	196	168	147

Primary Nozzles Index

High-flow (HF)

Quick Change Nozzle	Replacement Cap Gasket
10 pack	10 pack
PSHFQ4008	PM65BS205
PSHFQ4010	
PSHFQ4015	
PSHFQ4020	
PSHFQ4030	
PSHFQ4040	
PSHFQ4050	
PSHFQ4060	

Ultra-low-drift (ULD)

Quick Change Nozzle	Spray Tips	Caps	50 Mesh Strainers	Replacement Cap Gasket
10 pack	10 pack	10 pack	10 pack	40 pack
PSULDQ20015	PSULD20015	PS900015	PS310	PS17000255
PSULDQ2002	PSULD2002	PS90002		
PSULDQ20025	PSULD20025	PS900025		
PSULDQ2003	PSULD2003	PS90003		
PSULDQ2004	PSULD2004	PS90004		
PSULDQ2005	PSULD2005	PS90005		
PSULDQ2006	PSULD2006	PS90006		
PSULDQ2008	PSULD2008	PS90008		

3D

Quick Change Nozzle	50 Mesh Strainer	100 Mesh Strainer
10 pack	10 pack	10 pack
PS3DQ00015	PS310	PS311
PS3DQ0002	Sizes: 04-08	Sizes: 015-035
PS3DQ00025		
PS3DQ0003		
PS3DQ00035		
PS3DQ0004		
PS3DQ0005		
PS3DQ0006		
PS3DQ0008		

Low-drift Max (LDM)

Quick Change Nozzle	Replacement Cap Gasket
10 pack	40 pack
PSLDMQ2003	EPDM - PM200040-1
PSLDMQ2004	Viton - PM200040V1
PSLDMQ2005	
PSLDMQ2006	
PSLDMQ2008	
PSLDMQ2010	

Low-drift Twin (LDT)

Quick Change Nozzle	50 Mesh Strainer
10 pack	10 pack
PSLDTQ1003	PS0250
PSLDTQ1004	
PSLDTQ1005	
PSLDTQ1006	
PSLDTQ1008	
PSLDTQ1010	
PSLDTQ1012	
PSLDTQ1016	

Ultra-low-drift Max (ULDM)

Quick Change Nozzle	50 Mesh Strainer
10 pack	10 pack
PSULDMQ3002	PS0250
PSULDMQ30025	PSULDMQ30025
PSULDMQ3003	PSULDMQ3003
PSULDMQ3004	PSULDMQ3004
PSULDMQ3005	PSULDMQ3005
PSULDMQ3006	PSULDMQ3006
PSULDMQ3008	PSULDMQ3008





SECONDARY NOZZLES, CAPS, ADAPTERS AND NOZZLE BODIES

John Deere offers spray nozzles for a wide range of pressure ranges, flow rates and spray patterns to cover any spray applications. Correct nozzle selection is important to ensure your product is applied correctly.

Secondary Nozzles

STRAIGHT STREAM CERAMIC (STC)



The Straight Stream Ceramic (STC) provides an optimised solution for applying liquid fertilizer into solid seeded crops, such as timed nutrient applications. By providing a six-stream pattern, foliar contact is minimized and uniform coverage is ensured. The STC's ceramic metering orifice and low-pressure distribution chamber keeps the streams stable, reducing atomization and preventing leaf burn, making it ideal for top-dress use.

- A six-stream design distributes fertilizer more evenly than a three stream design
- Molded one piece design

Straight Stream Ceramic (STC) 110° spray angle - ASABE droplet size classification chart											
Tip size		015	02	03	04	05	06	08	10	15	20
Part Number		PSSTCQ10015	PSSTCQ1002	PSSTCQ1003	PSSTCQ1004	PSSTCQ1005	PSSTCQ1006	PSSTCQ1008	PSSTCQ1010	PSSTCQ1015	PSSTCQ1020
Pressure (Bar)	Pressure (PSI)										
1.0	15	S	S	S	S	S	S	S	S	S	S
1.4	20	S	S	S	S	S	S	S	S	S	S
2.0	30	S	S	S	S	S	S	S	S	S	S
2.8	40	S	S	S	S	S	S	S	S	S	S
3.4	50	S	S	S	S	S	S	S	S	S	S
4.1	60	S	S	S	S	S	S	S	S	S	S

Droplet data sourced at Pentair Hypro in a steady state condition per ASABE S572.3 Standard.

Features	
Common Use	Liquid Fertilizer
Pattern	Streaming
Technology	Pre-Orifice
Material	Ceramic
Spray Angle	110° Equivalent
Pressure Range	1.0 - 4.1 Bar (15-60 PSI)
Configuration	Quick Change

ExactApply™ Compatibility	
15Hz PWM	Yes
30Hz PWM	Yes
AutoSelect A/B	Yes
Conventional	Yes

Service Parts	
Cap gasket (sizes 015-06)	PM200040-1
Cap o-ring (sizes 08-15)	PM65BS205

Minimum Boom Height	
Nozzle spacing	Boom height
38cm	38cm
50cm	50cm

Secondary Nozzles

STRAIGHT STREAM CERAMIC APPLICATION CHART - 25CM NOZZLE SPACING

TIP SIZE	ASABE DROPLET SIZE	PRESSURE (BAR)	FLOW RATE (LPM)	APPLICATION RATE L/HA - 25 CM SPACING KM/H									
				8	10	12	14	15	20	25	30	35	40
015	S	1	0.35	104	83	69	59	55	42	33	28	24	21
	S	1.5	0.42	127	102	85	73	68	51	41	34	29	25
	S	2	0.49	147	118	98	84	78	59	47	39	34	29
	S	3	0.55	164	131	110	94	88	66	53	44	38	33
	S	3.5	0.60	180	144	120	103	96	72	58	48	41	36
	S	4	0.69	208	166	139	119	111	83	67	55	48	42
02	S	1	0.46	139	111	92	79	74	55	44	37	32	28
	S	1.5	0.57	170	136	113	97	91	68	54	45	39	34
	S	2	0.65	196	157	131	112	105	78	63	52	45	39
	S	3	0.73	219	175	146	125	117	88	70	58	50	44
	S	3.5	0.80	240	192	160	137	128	96	77	64	55	48
	S	4	0.92	277	222	185	158	148	111	89	74	63	55
025	S	1	0.58	173	139	115	99	92	69	55	46	40	35
	S	1.5	0.71	212	170	141	121	113	85	68	57	48	42
	S	2	0.82	245	196	163	140	131	98	78	65	56	49
	S	3	0.91	274	219	183	156	146	110	88	73	63	55
	S	3.5	1.00	300	240	200	171	160	120	96	80	69	60
	S	4	1.15	346	277	231	198	185	139	111	92	79	69
03	S	1	0.69	208	166	139	119	111	83	67	55	48	42
	S	1.5	0.85	255	204	170	146	136	102	82	68	58	51
	S	2	0.98	294	235	196	168	157	118	94	78	67	59
	S	3	1.10	329	263	219	188	175	131	105	88	75	66
	S	3.5	1.20	360	288	240	206	192	144	115	96	82	72
	S	4	1.39	416	333	277	238	222	166	133	111	95	83
035	S	1	0.81	242	194	162	139	129	97	78	65	55	48
	S	1.5	0.99	297	238	198	170	158	119	95	79	68	59
	S	2	1.14	343	274	229	196	183	137	110	91	78	69
	S	3	1.28	383	307	256	219	204	153	123	102	88	77
	S	3.5	1.40	420	336	280	240	224	168	134	112	96	84
	S	4	1.62	485	388	323	277	259	194	155	129	111	97
04	S	1	0.92	277	222	185	158	148	111	89	74	63	55
	S	1.5	1.13	339	271	226	194	181	136	109	90	78	68
	S	2	1.31	392	313	261	224	209	157	125	104	90	78
	S	3	1.46	438	351	292	250	234	175	140	117	100	88
	S	3.5	1.60	480	384	320	274	256	192	154	128	110	96
	S	4	1.85	554	444	370	317	296	222	177	148	127	111
05	S	1	1.16	347	277	231	198	185	139	111	92	79	69
	S	1.5	1.41	424	339	283	242	226	170	136	113	97	85
	S	2	1.63	490	392	327	280	261	196	157	131	112	98
	S	3	1.83	548	438	365	313	292	219	175	146	125	110
	S	3.5	2.00	600	480	400	343	320	240	192	160	137	120
	S	4	2.31	693	554	462	396	369	277	222	185	158	139

Continued on Next Page

Secondary Nozzles

STRAIGHT STREAM CERAMIC APPLICATION CHART - 25CM NOZZLE SPACING (CONTINUED)

TIP SIZE	ASABE DROPLET SIZE	PRESSURE (BAR)	FLOW RATE (LPM)	APPLICATION RATE L/HA - 25 CM SPACING KM/H									
				8	10	12	14	15	20	25	30	35	40
06	S	1	1.39	416	333	277	238	222	166	133	111	95	83
	S	1.5	1.70	509	407	339	291	272	204	163	136	116	102
	S	2	1.96	588	470	392	336	314	235	188	157	134	118
	S	3	2.19	657	526	438	376	351	263	210	175	150	131
	S	3.5	2.40	720	576	480	411	384	288	230	192	165	144
	S	4	2.77	831	665	554	475	443	333	266	222	190	166
08	S	1	1.85	554	443	370	317	296	222	177	148	127	111
	S	1.5	2.26	679	543	453	388	362	272	217	181	155	136
	S	2	2.61	784	627	523	448	418	314	251	209	179	157
	S	3	2.92	876	701	584	501	467	351	280	234	200	175
	S	3.5	3.20	960	768	640	549	512	384	307	256	219	192
	S	4	3.70	1109	887	739	633	591	443	355	296	253	222
10	S	1	2.31	693	554	462	396	370	277	222	185	158	139
	S	1.5	2.83	849	679	566	485	453	340	272	226	194	170
	S	2	3.27	981	785	654	561	523	392	314	262	224	196
	S	3	4.00	1200	960	800	686	640	480	384	320	274	240
	S	3.5	4.62	1386	1109	924	792	739	554	444	370	317	277
	S	4	5.16	1548	1238	1032	885	826	619	495	413	354	310
15	S	1	3.46	1038	830	692	593	554	415	332	277	237	208
	S	1.5	4.24	1272	1018	848	727	678	509	407	339	291	254
	S	2	4.90	1470	1176	980	840	784	588	470	392	336	294
	S	3	6.00	1800	1440	1200	1029	960	720	576	480	411	360
	S	3.5	6.93	2079	1663	1386	1188	1109	832	665	554	475	416
	S	4	7.75	2325	1860	1550	1329	1240	930	744	620	531	465
20	S	1	4.60	1380	1104	920	789	736	552	442	368	315	276
	S	1.5	5.70	1710	1368	1140	977	912	684	547	456	391	342
	S	2	6.50	1950	1560	1300	1114	1040	780	624	520	446	390
	S	3	8.00	2400	1920	1600	1371	1280	960	768	640	549	480
	S	3.5	8.50	2550	2040	1700	1457	1360	1020	816	680	583	510
	S	4	9.20	2760	2208	1840	1577	1472	1104	883	736	631	552

Secondary Nozzles

STRAIGHT STREAM CERAMIC APPLICATION CHART - 38CM NOZZLE SPACING

TIP SIZE	ASABE DROPLET SIZE	PRESSURE (BAR)	FLOW RATE (LPM)	APPLICATION RATE L/HA - 38 CM SPACING KM/H									
				8	10	12	14	15	20	25	30	35	40
015	F	1	0.35	68	55	46	39	36	27	22	18	16	14
	F	1.5	0.42	84	67	56	48	45	33	27	22	19	17
	F	2	0.49	97	77	64	55	52	39	31	26	22	19
	F	3	0.55	108	86	72	62	58	43	35	29	25	22
	F	4	0.60	118	95	79	68	63	47	38	32	27	24
	F	5	0.69	137	109	91	78	73	55	44	36	31	27
02	F	1	0.46	91	73	61	52	49	36	29	24	21	18
	F	1.5	0.57	112	89	74	64	60	45	36	30	26	22
	F	2	0.65	129	103	86	74	69	52	41	34	29	26
	F	3	0.73	144	115	96	82	77	58	46	38	33	29
	F	4	0.80	158	126	105	90	84	63	51	42	36	32
	F	5	0.92	182	146	122	104	97	73	58	49	42	36
025	M	1	0.58	114	91	76	65	61	46	36	30	26	23
	M	1.5	0.71	140	112	93	80	74	56	45	37	32	28
	F	2	0.82	161	129	107	92	86	64	52	43	37	32
	F	3	0.91	180	144	120	103	96	72	58	48	41	36
	F	4	1.00	197	158	132	113	105	79	63	53	45	39
	F	5	1.15	228	182	152	130	122	91	73	61	52	46
03	M	1	0.69	137	109	91	78	73	55	44	36	31	27
	M	1.5	0.85	168	134	112	96	89	67	54	45	38	34
	F	2	0.98	193	155	129	111	103	77	62	52	44	39
	F	3	1.10	216	173	144	123	115	86	69	58	49	43
	F	4	1.20	237	189	158	135	126	95	76	63	54	47
	F	5	1.39	274	219	182	156	146	109	88	73	63	55
035	M	1	0.81	159	128	106	91	85	64	51	43	36	32
	M	1.5	0.99	195	156	130	112	104	78	63	52	45	39
	M	2	1.14	226	180	150	129	120	90	72	60	52	45
	F	3	1.28	252	202	168	144	135	101	81	67	58	50
	F	4	1.40	276	221	184	158	147	111	88	74	63	55
	F	5	1.62	319	255	213	182	170	128	102	85	73	64
04	M	1	0.92	182	146	122	104	97	73	58	49	42	36
	M	1.5	1.13	223	179	149	128	119	89	71	60	51	45
	M	2	1.31	258	206	172	147	137	103	82	69	59	52
	F	3	1.46	288	231	192	165	154	115	92	77	66	58
	F	4	1.60	316	253	211	180	168	126	101	84	72	63
	F	5	1.85	365	292	243	208	195	146	117	97	83	73
05	M	1	1.16	228	182	152	130	122	91	73	61	52	46
	M	1.5	1.41	279	223	186	159	149	112	89	74	64	56
	M	2	1.63	322	258	215	184	172	129	103	86	74	64
	F	3	1.83	360	288	240	206	192	144	115	96	82	72
	F	4	2.00	395	316	263	226	211	158	126	105	90	79
	F	5	2.31	456	365	304	260	243	182	146	122	104	91

Continued on Next Page

Secondary Nozzles

STRAIGHT STREAM CERAMIC APPLICATION CHART - 38CM NOZZLE SPACING (CONTINUED)

TIP SIZE	ASABE DROPLET SIZE	PRESSURE (BAR)	FLOW RATE (LPM)	APPLICATION RATE L/HA - 38 CM SPACING KM/H									
				8	10	12	14	15	20	25	30	35	40
06	C	1	1.39	274	219	182	156	146	109	88	73	63	55
	M	1.5	1.70	335	268	223	191	179	134	107	89	77	67
	M	2	1.96	387	309	258	221	206	155	124	103	88	77
	M	3	2.19	432	346	288	247	231	173	138	115	99	86
	F	4	2.40	474	379	316	271	253	189	152	126	108	95
	F	5	2.77	547	438	365	313	292	219	175	146	125	109
08	C	1	1.85	365	292	243	208	194	146	117	97	83	73
	C	1.5	2.26	447	357	298	255	238	179	143	119	102	89
	M	2	2.61	516	413	344	295	275	206	165	138	118	103
	M	3	2.92	577	461	384	329	307	231	184	154	132	115
	M	4	3.20	632	505	421	361	337	253	202	168	144	126
	F	5	3.70	729	583	486	417	389	292	233	194	167	146
10	C	1	2.31	456	365	304	261	243	182	146	122	104	91
	C	1.5	2.83	559	447	372	319	298	223	179	149	128	112
	M	2	3.27	645	516	430	369	344	258	207	172	148	129
	M	3	4.00	789	632	526	451	421	316	253	211	180	158
	M	4	4.62	912	729	608	521	486	365	292	243	208	182
	F	5	5.16	1018	815	679	582	543	407	326	272	233	204
15	VC	1	3.46	683	546	455	390	364	273	219	182	156	137
	C	1.5	4.24	837	669	558	478	446	335	268	223	191	167
	C	2	4.90	967	774	645	553	516	387	309	258	221	193
	M	3	6.00	1184	947	789	677	632	474	379	316	271	237
	M	4	6.93	1368	1094	912	782	729	547	438	365	313	274
	M	5	7.75	1530	1224	1020	874	816	612	489	408	350	306

Secondary Nozzles

STRAIGHT STREAM CERAMIC APPLICATION CHART - 50CM NOZZLE SPACING

TIP SIZE	ASABE DROPLET SIZE	PRESSURE (BAR)	FLOW RATE (LPM)	APPLICATION RATE L/HA - 50 CM SPACING KM/H									
				8	10	12	14	15	20	25	30	35	40
015	F	1	0.35	52	42	35	30	28	21	17	14	12	10
	F	1.5	0.42	64	51	42	36	34	25	20	17	15	13
	F	2	0.49	73	59	49	42	39	29	24	20	17	15
	F	3	0.55	82	66	55	47	44	33	26	22	19	16
	F	4	0.60	90	72	60	51	48	36	29	24	21	18
	F	5	0.69	104	83	69	59	55	42	33	28	24	21
02	F	1	0.46	69	55	46	40	37	28	22	18	16	14
	F	1.5	0.57	85	68	57	48	45	34	27	23	19	17
	F	2	0.65	98	78	65	56	52	39	31	26	22	20
	F	3	0.73	110	88	73	63	58	44	35	29	25	22
	F	4	0.80	120	96	80	69	64	48	38	32	27	24
	F	5	0.92	139	111	92	79	74	55	44	37	32	28
025	M	1	0.58	87	69	58	49	46	35	28	23	20	17
	M	1.5	0.71	106	85	71	61	57	42	34	28	24	21
	F	2	0.82	122	98	82	70	65	49	39	33	28	24
	F	3	0.91	137	110	91	78	73	55	44	37	31	27
	F	4	1.00	150	120	100	86	80	60	48	40	34	30
	F	5	1.15	173	139	115	99	92	69	55	46	40	35
03	M	1	0.69	104	83	69	59	55	42	33	28	24	21
	M	1.5	0.85	127	102	85	73	68	51	41	34	29	25
	F	2	0.98	147	118	98	84	78	59	47	39	34	29
	F	3	1.10	164	131	110	94	88	66	53	44	38	33
	F	4	1.20	180	144	120	103	96	72	58	48	41	36
	F	5	1.39	208	166	139	119	111	83	67	55	48	42
035	M	1	0.81	121	97	81	69	65	48	39	32	28	24
	M	1.5	0.99	149	119	99	85	79	59	48	40	34	30
	M	2	1.14	171	137	114	98	91	69	55	46	39	34
	F	3	1.28	192	153	128	110	102	77	61	51	44	38
	F	4	1.40	210	168	140	120	112	84	67	56	48	42
	F	5	1.62	243	194	162	139	129	97	78	65	55	49
04	M	1	0.92	139	111	92	79	74	55	44	37	32	28
	M	1.5	1.13	170	136	113	97	90	68	54	45	39	34
	M	2	1.31	196	157	131	112	104	78	63	52	45	39
	F	3	1.46	219	175	146	125	117	88	70	58	50	44
	F	4	1.60	240	192	160	137	128	96	77	64	55	48
	F	5	1.85	277	222	185	158	148	111	89	74	63	55

Continued on Next Page

Secondary Nozzles

STRAIGHT STREAM CERAMIC APPLICATION CHART - 50CM NOZZLE SPACING (CONTINUED)

TIP SIZE	ASABE DROPLET SIZE	PRESSURE (BAR)	FLOW RATE (LPM)	APPLICATION RATE L/HA - 50 CM SPACING KM/H									
				8	10	12	14	15	20	25	30	35	40
05	M	1	1.16	173	139	116	99	92	69	55	46	40	35
	M	1.5	1.41	212	170	141	121	113	85	68	57	48	42
	M	2	1.63	245	196	163	140	131	98	78	65	56	49
	F	3	1.83	274	219	183	157	146	110	88	73	63	55
	F	4	2.00	300	240	200	171	160	120	96	80	69	60
	F	5	2.31	346	277	231	198	185	139	111	92	79	69
06	C	1	1.39	208	166	139	119	111	83	67	55	48	42
	M	1.5	1.70	255	204	170	145	136	102	81	68	58	51
	M	2	1.96	294	235	196	168	157	118	94	78	67	59
	M	3	2.19	329	263	219	188	175	131	105	88	75	66
	F	4	2.40	360	288	240	206	192	144	115	96	82	72
	F	5	2.77	416	333	277	238	222	166	133	111	95	83
08	C	1	1.85	277	222	185	158	148	111	89	74	63	55
	C	1.5	2.26	339	272	226	194	181	136	109	91	78	68
	M	2	2.61	392	314	261	224	209	157	125	105	90	78
	M	3	2.92	438	351	292	250	234	175	140	117	100	88
	M	4	3.20	480	384	320	274	256	192	154	128	110	96
	F	5	3.70	554	443	370	317	296	222	177	148	127	111
10	C	1	2.31	347	277	231	198	185	139	111	92	79	69
	C	1.5	2.83	425	340	283	243	226	170	136	113	97	85
	M	2	3.27	491	392	327	280	262	196	157	131	112	98
	M	3	4.00	600	480	400	343	320	240	192	160	137	120
	M	4	4.62	693	554	462	396	370	277	222	185	158	139
	F	5	5.16	774	619	516	442	413	310	248	206	177	155
15	VC	1	3.46	519	415	346	297	277	208	166	138	119	104
	C	1.5	4.24	636	509	424	363	339	254	204	170	145	127
	C	2	4.90	735	588	490	420	392	294	235	196	168	147
	M	3	6.00	900	720	600	514	480	360	288	240	206	180
	M	4	6.93	1040	832	693	594	554	416	333	277	238	208
	M	5	7.75	1163	930	775	664	620	465	372	310	266	233

Secondary Nozzles

GUARDIANAIR TWIN™ (GAT) 110°



The GuardianAIR Twin spray nozzles are the best choice for high-coverage applications where on-target spray delivery is important. The GAT is ideal for penetrating complex canopies, such as soybeans or cereal grains, where both coverage of the target and reduction of drift potential are important.

- High-coverage forward (30°) and rear-facing (30°) fans penetrate dense canopies
- A large single-metering orifice is used reducing the risk of nozzle plugging
- Quick Change nozzle assembly includes tips, cap, gasket, and integrated strainer

GuardianAir Twin (GAT) 110° spray angle - ASABE droplet size classification chart									
Tip size		02	025	03	035	04	05	06	08
Part Number		PSGAT1002	PSGAT10025	PSGAT1003	PSGAT10035	PSGAT1004	PSGAT1005	PSGAT1006	PSGAT1008
Pressure (Bar)	Pressure (PSI)								
1.4	20	---	---	---	---	XC	XC	XC	XC
2.0	30	C	UC	VC	XC	VC	VC	XC	VC
2.8	40	M	VC	C	VC	C	C	VC	C
3.4	50	M	C	M	C	C	C	C	C
4.1	60	M	M	M	M	M	M	C	C
4.8	70	M	M	M	M	M	M	M	M
5.5	80	M	M	M	M	M	M	M	M
5.9	85	M	M	M	M	M	M	M	M

Droplet data sourced at Silsoe Spray Applications Unit Ltd in a steady state condition per ASABE S572.3 Standard.

Features	
Common Use	Plant Health
Pattern	Tapered Flan Fan-Twin Outlet
Technology	Air Induction
Material	Polyacetal
Spray Angle	110°
Spray Incline	30° forward +
	30° rearward
Pressure Range	2.0 - 5.9 Bar (30-85 PSI) (sizes 02-035)
	1.4 - 5.9 Bar (20-85 PSI) (sizes 04-08)
Configuration	Quick Change

ExactApply™ Compatibility	
15Hz PWM	No
30Hz PWM	No
AutoSelect A/B	Yes
Conventional	Yes

Minimum Boom Height	
Nozzle Spacing	Boom Height
38cm	38cm
50cm	50cm

Service Parts	
Cap gasket (EPDM)	PM65BS205
Strainer (50 mesh)	PS0250

Secondary Nozzles

GUARDIANAIR TWIN™ APPLICATION CHART - 25CM NOZZLE SPACING

TIP SIZE	ASABE DROPLET SIZE	PRESSURE (BAR)	FLOW RATE (LPM)	APPLICATION RATE L/HA - 25 CM SPACING KM/H									
				8	10	12	14	15	20	25	30	35	40
02	C	2	0.65	195	156	130	111	104	78	62	52	45	39
	M	3	0.80	240	192	160	137	128	96	77	64	55	48
	M	4	0.92	276	221	184	158	147	110	88	74	63	55
	M	5	1.03	309	247	206	177	165	124	99	82	71	62
	M	6	1.13	339	271	226	194	181	136	108	90	77	68
	F	7	1.22	366	293	244	209	195	146	117	98	84	73
	F	8	1.31	393	314	262	225	210	157	126	105	90	79
025	UC	2	0.82	246	197	164	141	131	98	79	66	56	49
	VC	3	1.00	300	240	200	171	160	120	96	80	69	60
	M	4	1.15	345	276	230	197	184	138	110	92	79	69
	M	5	1.29	387	310	258	221	206	155	124	103	88	77
	M	6	1.41	423	338	282	242	226	169	135	113	97	85
	M	7	1.53	459	367	306	262	245	184	147	122	105	92
	M	8	1.63	489	391	326	279	261	196	156	130	112	98
03	VC	2	0.98	294	235	196	168	157	118	94	78	67	59
	C	3	1.20	360	288	240	206	192	144	115	96	82	72
	M	4	1.39	417	334	278	238	222	167	133	111	95	83
	M	5	1.55	465	372	310	266	248	186	149	124	106	93
	M	6	1.70	510	408	340	291	272	204	163	136	117	102
	M	7	1.83	549	439	366	314	293	220	176	146	125	110
	M	8	1.96	588	470	392	336	314	235	188	157	134	118
035	EC	2	1.14	342	274	228	195	182	137	109	91	78	68
	C	3	1.40	420	336	280	240	224	168	134	112	96	84
	M	4	1.62	486	389	324	278	259	194	156	130	111	97
	M	5	1.81	543	434	362	310	290	217	174	145	124	109
	M	6	1.98	594	475	396	339	317	238	190	158	136	119
	M	7	2.14	642	514	428	367	342	257	205	171	147	128
	M	8	2.29	687	550	458	393	366	275	220	183	157	137
04	VC	2	1.31	393	314	262	225	210	157	126	105	90	79
	C	3	1.60	480	384	320	274	256	192	154	128	110	96
	M	4	1.85	555	444	370	317	296	222	178	148	127	111
	M	5	2.07	621	497	414	355	331	248	199	166	142	124
	M	6	2.26	678	542	452	387	362	271	217	181	155	136
	M	7	2.44	732	586	488	418	390	293	234	195	167	146
	M	8	2.61	783	626	522	447	418	313	251	209	179	157

Continued on Next Page

Secondary Nozzles

GUARDIANAIR TWIN™ APPLICATION CHART - 25CM NOZZLE SPACING (CONTINUED)

TIP SIZE	ASABE DROPLET SIZE	PRESSURE (BAR)	FLOW RATE (LPM)	APPLICATION RATE L/HA - 25 CM SPACING KM/H									
				8	10	12	14	15	20	25	30	35	40
05	VC	2	1.63	489	391	326	279	261	196	156	130	112	98
	C	3	2.00	600	480	400	343	320	240	192	160	137	120
	M	4	2.31	693	554	462	396	370	277	222	185	158	139
	M	5	2.58	774	619	516	442	413	310	248	206	177	155
	M	6	2.83	849	679	566	485	453	340	272	226	194	170
	M	7	3.06	918	734	612	525	490	367	294	245	210	184
	M	8	3.27	981	785	654	561	523	392	314	262	224	196
06	EC	2	1.96	588	470	392	336	314	235	188	157	134	118
	C	3	2.40	720	576	480	411	384	288	230	192	165	144
	C	4	2.77	831	665	554	475	443	332	266	222	190	166
	M	5	3.10	930	744	620	531	496	372	298	248	213	186
	M	6	3.39	1017	814	678	581	542	407	325	271	232	203
	M	7	3.67	1101	881	734	629	587	440	352	294	252	220
	M	8	3.92	1176	941	784	672	627	470	376	314	269	235
08	VC	2	2.61	783	626	522	447	418	313	251	209	179	157
	C	3	3.20	960	768	640	549	512	384	307	256	219	192
	C	4	3.70	1110	888	740	634	592	444	355	296	254	222
	M	5	4.13	1239	991	826	708	661	496	396	330	283	248
	M	6	4.53	1359	1087	906	777	725	544	435	362	311	272
	M	7	4.89	1467	1174	978	838	782	587	469	391	335	293
	M	8	5.23	1569	1255	1046	897	837	628	502	418	359	314

Secondary Nozzles

GUARDIANAIR TWIN™ APPLICATION CHART - 38CM NOZZLE SPACING

TIP SIZE	ASABE DROPLET SIZE	PRESSURE (BAR)	FLOW RATE (LPM)	APPLICATION RATE L/HA - 38 CM SPACING KM/H									
				8	10	12	14	15	20	25	30	35	40
02	C	2	0.65	128	103	86	73	68	51	41	34	29	26
	M	3	0.80	158	126	105	90	84	63	51	42	36	32
	M	4	0.92	182	145	121	104	97	73	58	48	42	36
	M	5	1.03	203	163	136	116	108	81	65	54	46	41
	M	6	1.13	223	178	149	127	119	89	71	59	51	45
	F	7	1.22	241	193	161	138	128	96	77	64	55	48
	F	8	1.31	259	207	172	148	138	103	83	69	59	52
025	UC	2	0.82	162	129	108	92	86	65	52	43	37	32
	VC	3	1.00	197	158	132	113	105	79	63	53	45	39
	M	4	1.15	227	182	151	130	121	91	73	61	52	45
	M	5	1.29	255	204	170	145	136	102	81	68	58	51
	M	6	1.41	278	223	186	159	148	111	89	74	64	56
	M	7	1.53	302	242	201	173	161	121	97	81	69	60
	M	8	1.63	322	257	214	184	172	129	103	86	74	64
03	VC	2	0.98	193	155	129	111	103	77	62	52	44	39
	C	3	1.20	237	189	158	135	126	95	76	63	54	47
	M	4	1.39	274	219	183	157	146	110	88	73	63	55
	M	5	1.55	306	245	204	175	163	122	98	82	70	61
	M	6	1.70	336	268	224	192	179	134	107	89	77	67
	M	7	1.83	361	289	241	206	193	144	116	96	83	72
	M	8	1.96	387	309	258	221	206	155	124	103	88	77
035	EC	2	1.14	225	180	150	129	120	90	72	60	51	45
	C	3	1.40	276	221	184	158	147	111	88	74	63	55
	M	4	1.62	320	256	213	183	171	128	102	85	73	64
	M	5	1.81	357	286	238	204	191	143	114	95	82	71
	M	6	1.98	391	313	261	223	208	156	125	104	89	78
	M	7	2.14	422	338	282	241	225	169	135	113	97	84
	M	8	2.29	452	362	301	258	241	181	145	121	103	90
04	VC	2	1.31	259	207	172	148	138	103	83	69	59	52
	C	3	1.60	316	253	211	180	168	126	101	84	72	63
	M	4	1.85	365	292	243	209	195	146	117	97	83	73
	M	5	2.07	409	327	272	233	218	163	131	109	93	82
	M	6	2.26	446	357	297	255	238	178	143	119	102	89
	M	7	2.44	482	385	321	275	257	193	154	128	110	96
	M	8	2.61	515	412	343	294	275	206	165	137	118	103

Continued on Next Page

Secondary Nozzles

GUARDIANAIR TWIN™ APPLICATION CHART - 38CM NOZZLE SPACING (CONTINUED)

TIP SIZE	ASABE DROPLET SIZE	PRESSURE (BAR)	FLOW RATE (LPM)	APPLICATION RATE L/HA - 38 CM SPACING KM/H									
				8	10	12	14	15	20	25	30	35	40
05	VC	2	1.63	322	257	214	184	172	129	103	86	74	64
	C	3	2.00	395	316	263	226	211	158	126	105	90	79
	M	4	2.31	456	365	304	261	243	182	146	122	104	91
	M	5	2.58	509	407	339	291	272	204	163	136	116	102
	M	6	2.83	559	447	372	319	298	223	179	149	128	112
	M	7	3.06	604	483	403	345	322	242	193	161	138	121
	M	8	3.27	645	516	430	369	344	258	207	172	148	129
06	EC	2	1.96	387	309	258	221	206	155	124	103	88	77
	C	3	2.40	474	379	316	271	253	189	152	126	108	95
	C	4	2.77	547	437	364	312	292	219	175	146	125	109
	M	5	3.10	612	489	408	350	326	245	196	163	140	122
	M	6	3.39	669	535	446	382	357	268	214	178	153	134
	M	7	3.67	724	579	483	414	386	290	232	193	166	145
	M	8	3.92	774	619	516	442	413	309	248	206	177	155
08	VC	2	2.61	515	412	343	294	275	206	165	137	118	103
	C	3	3.20	632	505	421	361	337	253	202	168	144	126
	C	4	3.70	730	584	487	417	389	292	234	195	167	146
	M	5	4.13	815	652	543	466	435	326	261	217	186	163
	M	6	4.53	894	715	596	511	477	358	286	238	204	179
	M	7	4.89	965	772	643	552	515	386	309	257	221	193
	M	8	5.23	1032	826	688	590	551	413	330	275	236	206

Secondary Nozzles

GUARDIANAIR TWIN™ APPLICATION CHART - 50CM NOZZLE SPACING

TIP SIZE	ASABE DROPLET SIZE	PRESSURE (BAR)	FLOW RATE (LPM)	APPLICATION RATE L/HA - 50 CM SPACING KM/H									
				8	10	12	14	15	20	25	30	35	40
02	C	2	0.65	98	78	65	56	52	39	31	26	22	20
	M	3	0.80	120	96	80	69	64	48	38	32	27	24
	M	4	0.92	138	110	92	79	74	55	44	37	32	28
	M	5	1.03	155	124	103	88	82	62	49	41	35	31
	M	6	1.13	170	136	113	97	90	68	54	45	39	34
	F	7	1.22	183	146	122	105	98	73	59	49	42	37
	F	8	1.31	197	157	131	112	105	79	63	52	45	39
025	UC	2	0.82	123	98	82	70	66	49	39	33	28	25
	VC	3	1.00	150	120	100	86	80	60	48	40	34	30
	M	4	1.15	173	138	115	99	92	69	55	46	39	35
	M	5	1.29	194	155	129	111	103	77	62	52	44	39
	M	6	1.41	212	169	141	121	113	85	68	56	48	42
	M	7	1.53	230	184	153	131	122	92	73	61	52	46
	M	8	1.63	245	196	163	140	130	98	78	65	56	49
03	VC	2	0.98	147	118	98	84	78	59	47	39	34	29
	C	3	1.20	180	144	120	103	96	72	58	48	41	36
	M	4	1.39	209	167	139	119	111	83	67	56	48	42
	M	5	1.55	233	186	155	133	124	93	74	62	53	47
	M	6	1.70	255	204	170	146	136	102	82	68	58	51
	M	7	1.83	275	220	183	157	146	110	88	73	63	55
	M	8	1.96	294	235	196	168	157	118	94	78	67	59
035	EC	2	1.14	171	137	114	98	91	68	55	46	39	34
	C	3	1.40	210	168	140	120	112	84	67	56	48	42
	M	4	1.62	243	194	162	139	130	97	78	65	56	49
	M	5	1.81	272	217	181	155	145	109	87	72	62	54
	M	6	1.98	297	238	198	170	158	119	95	79	68	59
	M	7	2.14	321	257	214	183	171	128	103	86	73	64
	M	8	2.29	344	275	229	196	183	137	110	92	79	69
04	VC	2	1.31	197	157	131	112	105	79	63	52	45	39
	C	3	1.60	240	192	160	137	128	96	77	64	55	48
	M	4	1.85	278	222	185	159	148	111	89	74	63	56
	M	5	2.07	311	248	207	177	166	124	99	83	71	62
	M	6	2.26	339	271	226	194	181	136	108	90	77	68
	M	7	2.44	366	293	244	209	195	146	117	98	84	73
	M	8	2.61	392	313	261	224	209	157	125	104	89	78

Continued on Next Page

Secondary Nozzles

GUARDIANAIR TWIN™ APPLICATION CHART - 50CM NOZZLE SPACING (CONTINUED)

TIP SIZE	ASABE DROPLET SIZE	PRESSURE (BAR)	FLOW RATE (LPM)	APPLICATION RATE L/HA - 50 CM SPACING KM/H									
				8	10	12	14	15	20	25	30	35	40
05	VC	2	1.63	245	196	163	140	130	98	78	65	56	49
	C	3	2.00	300	240	200	171	160	120	96	80	69	60
	M	4	2.31	347	277	231	198	185	139	111	92	79	69
	M	5	2.58	387	310	258	221	206	155	124	103	88	77
	M	6	2.83	425	340	283	243	226	170	136	113	97	85
	M	7	3.06	459	367	306	262	245	184	147	122	105	92
	M	8	3.27	491	392	327	280	262	196	157	131	112	98
06	EC	2	1.96	294	235	196	168	157	118	94	78	67	59
	C	3	2.40	360	288	240	206	192	144	115	96	82	72
	C	4	2.77	416	332	277	237	222	166	133	111	95	83
	M	5	3.10	465	372	310	266	248	186	149	124	106	93
	M	6	3.39	509	407	339	291	271	203	163	136	116	102
	M	7	3.67	551	440	367	315	294	220	176	147	126	110
	M	8	3.92	588	470	392	336	314	235	188	157	134	118
08	VC	2	2.61	392	313	261	224	209	157	125	104	89	78
	C	3	3.20	480	384	320	274	256	192	154	128	110	96
	C	4	3.70	555	444	370	317	296	222	178	148	127	111
	M	5	4.13	620	496	413	354	330	248	198	165	142	124
	M	6	4.53	680	544	453	388	362	272	217	181	155	136
	M	7	4.89	734	587	489	419	391	293	235	196	168	147
	M	8	5.23	785	628	523	448	418	314	251	209	179	157

Secondary Nozzles



LOW-DRIFT AIR (LDA) 110°

The Low-drift Air (LDA) spray nozzle maintains a steady exchange between droplet and spray pressure creating more uniform coverage of post-emerge plant health protectants and contact herbicides.

- Air-filled droplets reduce drift while increasing droplet deposition and retention on foliage
- Speed-optimised spray incline allows more uniform coverage
- Quick Change nozzle assembly includes tip, cap, and gasket

Low-drift Air (LDA) 110° spray angle - ASABE droplet size classification chart								
Tip size		015	02	025	03	035	04	05
Part Number		PSLDAQ10015	PSLDAQ1002	PSLDAQ10025	PSLDAQ1003	PSLDAQ10035	PSLDAQ1004	PSLDAQ1005
Tip Only Number		PSLDA10015	PSLDA1002	PSLDA10025	PSLDA1003	PSLDA10035	PSLDA1004	PSLDA1005
Cap Number		PS900015	PS90002	PS900025	PS90003	PS900035	PS90004	PS90005
Pressure (Bar)	Pressure (PSI)							
1.0	15	UC	UC	UC	UC	UC	UC	UC
1.4	20	UC	XC	UC	UC	XC	UC	UC
2.0	30	XC	C	VC	XC	VC	VC	VC
2.8	40	C	C	C	VC	C	C	VC
3.4	50	C	M	M	C	M	C	C
4.1	60	M	M	M	C	M	M	C
4.8	70	M	M	M	M	M	M	M
5.5	80	M	M	M	M	M	M	M
5.9	85	M	M	M	M	M	M	M

Droplet data sourced at Silsoe Spray Applications Unit Ltd in a steady state condition per ASABE S572.3 Standard.

Features	
Common Use	Contact Herbicide
Pattern	Tapered Flat Fan
Technology	Air Induction
Material	Polycetal
Spray Angle	110°
Spray Incline	Rearward, 10° to 13° (depending on size)
Pressure Range	15-85 PSI
Configuration	Quick Change

ExactApply™ compatibility	
15Hz PWM	No
30Hz PWM	No
AutoSelect A/B	Yes
Conventional	Yes

Minimum boom height	
Nozzle spacing	Boom height
38cm	38cm
50cm	50cm

Service Parts	
Cap Gasket (EPDM)	PM200040-1
Cap Gasket (Viton)	PM200040V1

Secondary Nozzles

LOW-DRIFT AIR APPLICATION CHART - 25CM NOZZLE SPACING

TIP SIZE	ASABE DROPLET SIZE	PRESSURE (BAR)	FLOW RATE (LPM)	APPLICATION RATE L/HA - 25 CM SPACING KM/H									
				8	10	12	14	15	20	25	30	35	40
015	UC	1	0.35	104	83	69	59	55	42	33	28	24	21
	UC	1.5	0.42	127	102	85	73	68	51	41	34	29	25
	EC	2	0.49	147	118	98	84	78	59	47	39	34	29
	C	3	0.60	180	144	120	103	96	72	58	48	41	36
	M	4	0.69	207	166	138	118	110	83	66	55	47	41
	M	5	0.77	231	185	154	132	123	92	74	62	53	46
	M	6	0.85	255	204	170	146	136	102	82	68	58	51
	M	7	0.92	276	221	184	158	147	110	88	74	63	55
02	UC	1	0.46	139	111	92	79	74	55	44	37	32	28
	EC	1.5	0.57	170	136	113	97	91	68	54	45	39	34
	VC	2	0.65	196	157	131	112	105	78	63	52	45	39
	M	3	0.80	240	192	160	137	128	96	77	64	55	48
	M	4	0.92	276	221	184	158	147	110	88	74	63	55
	M	5	1.03	309	247	206	177	165	124	99	82	71	62
	M	6	1.13	339	271	226	194	181	136	108	90	77	68
	M	7	1.22	366	293	244	209	195	146	117	98	84	73
025	UC	1	0.58	173	139	115	99	92	69	55	46	40	35
	EC	1.5	0.71	212	170	141	121	113	85	68	57	48	42
	VC	2	0.82	245	196	163	140	131	98	78	65	56	49
	C	3	1.00	300	240	200	171	160	120	96	80	69	60
	M	4	1.15	345	276	230	197	184	138	110	92	79	69
	M	5	1.29	387	310	258	221	206	155	124	103	88	77
	M	6	1.41	423	338	282	242	226	169	135	113	97	85
	M	7	1.53	459	367	306	262	245	184	147	122	105	92
03	UC	1	0.69	208	166	139	119	111	83	67	55	48	42
	UC	1.5	0.85	255	204	170	146	136	102	82	68	58	51
	EC	2	0.98	294	235	196	168	157	118	94	78	67	59
	VC	3	1.20	360	288	240	206	192	144	115	96	82	72
	C	4	1.39	417	334	278	238	222	167	133	111	95	83
	M	5	1.55	465	372	310	266	248	186	149	124	106	93
	M	6	1.70	510	408	340	291	272	204	163	136	117	102
	M	7	1.83	549	439	366	314	293	220	176	146	125	110
035	UC	1	0.81	242	194	162	139	129	97	78	65	55	48
	EC	1.5	0.99	297	238	198	170	158	119	95	79	68	59
	VC	2	1.14	343	274	229	196	183	137	110	91	78	69
	C	3	1.40	420	336	280	240	224	168	134	112	96	84
	M	4	1.62	486	389	324	278	259	194	156	130	111	97
	M	5	1.81	543	434	362	310	290	217	174	145	124	109
	M	6	1.98	594	475	396	339	317	238	190	158	136	119
	M	7	2.14	642	514	428	367	342	257	205	171	147	128

Continued on Next Page

Secondary Nozzles

LOW-DRIFT AIR APPLICATION CHART - 25CM NOZZLE SPACING (CONTINUED)

TIP SIZE	ASABE DROPLET SIZE	PRESSURE (BAR)	FLOW RATE (LPM)	APPLICATION RATE L/HA - 25 CM SPACING KM/H									
				8	10	12	14	15	20	25	30	35	40
04	UC	1	0.92	277	222	185	158	148	111	89	74	63	55
	EC	1.5	1.13	339	271	226	194	181	136	109	90	78	68
	VC	2	1.31	392	313	261	224	209	157	125	104	90	78
	C	3	1.60	480	384	320	274	256	192	154	128	110	96
	M	4	1.85	555	444	370	317	296	222	178	148	127	111
	M	5	2.07	621	497	414	355	331	248	199	166	142	124
	M	6	2.26	678	542	452	387	362	271	217	181	155	136
	M	7	2.44	732	586	488	418	390	293	234	195	167	146
05	UC	1	1.16	347	277	231	198	185	139	111	92	79	69
	EC	1.5	1.41	424	339	283	242	226	170	136	113	97	85
	EC	2	1.63	490	392	327	280	261	196	157	131	112	98
	C	3	2.00	600	480	400	343	320	240	192	160	137	120
	C	4	2.31	693	554	462	396	370	277	222	185	158	139
	M	5	2.58	774	619	516	442	413	310	248	206	177	155
	M	6	2.83	849	679	566	485	453	340	272	226	194	170
	M	7	3.06	918	734	612	525	490	367	294	245	210	184

Secondary Nozzles

LOW-DRIFT AIR APPLICATION CHART - 38CM NOZZLE SPACING

TIP SIZE	ASABE DROPLET SIZE	PRESSURE (BAR)	FLOW RATE (LPM)	APPLICATION RATE L/HA - 38 CM SPACING KM/H									
				8	10	12	14	15	20	25	30	35	40
015	UC	1	0.35	68	55	46	39	36	27	22	18	16	14
	UC	1.5	0.42	84	67	56	48	45	33	27	22	19	17
	EC	2	0.49	97	77	64	55	52	39	31	26	22	19
	C	3	0.60	118	95	79	68	63	47	38	32	27	24
	M	4	0.69	136	109	91	78	73	54	44	36	31	27
	M	5	0.77	152	122	101	87	81	61	49	41	35	30
	M	6	0.85	168	134	112	96	89	67	54	45	38	34
	M	7	0.92	182	145	121	104	97	73	58	48	42	36
02	UC	1	0.46	91	73	61	52	49	36	29	24	21	18
	EC	1.5	0.57	112	89	74	64	60	45	36	30	26	22
	VC	2	0.65	129	103	86	74	69	52	41	34	29	26
	M	3	0.80	158	126	105	90	84	63	51	42	36	32
	M	4	0.92	182	145	121	104	97	73	58	48	42	36
	M	5	1.03	203	163	136	116	108	81	65	54	46	41
	M	6	1.13	223	178	149	127	119	89	71	59	51	45
	M	7	1.22	241	193	161	138	128	96	77	64	55	48
025	UC	1	0.58	114	91	76	65	61	46	36	30	26	23
	EC	1.5	0.71	140	112	93	80	74	56	45	37	32	28
	VC	2	0.82	161	129	107	92	86	64	52	43	37	32
	C	3	1.00	197	158	132	113	105	79	63	53	45	39
	M	4	1.15	227	182	151	130	121	91	73	61	52	45
	M	5	1.29	255	204	170	145	136	102	81	68	58	51
	M	6	1.41	278	223	186	159	148	111	89	74	64	56
	M	7	1.53	302	242	201	173	161	121	97	81	69	60
03	UC	1	0.69	137	109	91	78	73	55	44	36	31	27
	UC	1.5	0.85	168	134	112	96	89	67	54	45	38	34
	EC	2	0.98	193	155	129	111	103	77	62	52	44	39
	VC	3	1.20	237	189	158	135	126	95	76	63	54	47
	C	4	1.39	274	219	183	157	146	110	88	73	63	55
	M	5	1.55	306	245	204	175	163	122	98	82	70	61
	M	6	1.70	336	268	224	192	179	134	107	89	77	67
	M	7	1.83	361	289	241	206	193	144	116	96	83	72
035	UC	1	0.81	159	128	106	91	85	64	51	43	36	32
	EC	1.5	0.99	195	156	130	112	104	78	63	52	45	39
	VC	2	1.14	226	180	150	129	120	90	72	60	52	45
	C	3	1.40	276	221	184	158	147	111	88	74	63	55
	M	4	1.62	320	256	213	183	171	128	102	85	73	64
	M	5	1.81	357	286	238	204	191	143	114	95	82	71
	M	6	1.98	391	313	261	223	208	156	125	104	89	78
	M	7	2.14	422	338	282	241	225	169	135	113	97	84

Continued on Next Page

Secondary Nozzles

LOW-DRIFT AIR APPLICATION CHART - 38CM NOZZLE SPACING (CONTINUED)

TIP SIZE	ASABE DROPLET SIZE	PRESSURE (BAR)	FLOW RATE (LPM)	APPLICATION RATE L/HA - 38 CM SPACING KM/H									
				8	10	12	14	15	20	25	30	35	40
04	UC	1	0.92	182	146	122	104	97	73	58	49	42	36
	EC	1.5	1.13	223	179	149	128	119	89	71	60	51	45
	VC	2	1.31	258	206	172	147	137	103	82	69	59	52
	C	3	1.60	316	253	211	180	168	126	101	84	72	63
	M	4	1.85	365	292	243	209	195	146	117	97	83	73
	M	5	2.07	409	327	272	233	218	163	131	109	93	82
	M	6	2.26	446	357	297	255	238	178	143	119	102	89
	M	7	2.44	482	385	321	275	257	193	154	128	110	96
05	UC	1	1.16	228	182	152	130	122	91	73	61	52	46
	EC	1.5	1.41	279	223	186	159	149	112	89	74	64	56
	EC	2	1.63	322	258	215	184	172	129	103	86	74	64
	C	3	2.00	395	316	263	226	211	158	126	105	90	79
	C	4	2.31	456	365	304	261	243	182	146	122	104	91
	M	5	2.58	509	407	339	291	272	204	163	136	116	102
	M	6	2.83	559	447	372	319	298	223	179	149	128	112
	M	7	3.06	604	483	403	345	322	242	193	161	138	121

Secondary Nozzles

LOW-DRIFT AIR APPLICATION CHART - 50CM NOZZLE SPACING

TIP SIZE	ASABE DROPLET SIZE	PRESSURE (BAR)	FLOW RATE (LPM)	APPLICATION RATE L/HA - 50 CM SPACING KM/H									
				8	10	12	14	15	20	25	30	35	40
015	UC	1	0.35	52	42	35	30	28	21	17	14	12	10
	UC	1.5	0.42	64	51	42	36	34	25	20	17	15	13
	EC	2	0.49	73	59	49	42	39	29	24	20	17	15
	C	3	0.60	90	72	60	51	48	36	29	24	21	18
	M	4	0.69	104	83	69	59	55	41	33	28	24	21
	M	5	0.77	116	92	77	66	62	46	37	31	26	23
	M	6	0.85	128	102	85	73	68	51	41	34	29	26
	M	7	0.92	138	110	92	79	74	55	44	37	32	28
02	UC	1	0.46	69	55	46	40	37	28	22	18	16	14
	EC	1.5	0.57	85	68	57	48	45	34	27	23	19	17
	VC	2	0.65	98	78	65	56	52	39	31	26	22	20
	M	3	0.80	120	96	80	69	64	48	38	32	27	24
	M	4	0.92	138	110	92	79	74	55	44	37	32	28
	M	5	1.03	155	124	103	88	82	62	49	41	35	31
	M	6	1.13	170	136	113	97	90	68	54	45	39	34
	M	7	1.22	183	146	122	105	98	73	59	49	42	37
025	UC	1	0.58	87	69	58	49	46	35	28	23	20	17
	EC	1.5	0.71	106	85	71	61	57	42	34	28	24	21
	VC	2	0.82	122	98	82	70	65	49	39	33	28	24
	C	3	1.00	150	120	100	86	80	60	48	40	34	30
	M	4	1.15	173	138	115	99	92	69	55	46	39	35
	M	5	1.29	194	155	129	111	103	77	62	52	44	39
	M	6	1.41	212	169	141	121	113	85	68	56	48	42
	M	7	1.53	230	184	153	131	122	92	73	61	52	46
03	UC	1	0.69	104	83	69	59	55	42	33	28	24	21
	UC	1.5	0.85	127	102	85	73	68	51	41	34	29	25
	EC	2	0.98	147	118	98	84	78	59	47	39	34	29
	VC	3	1.20	180	144	120	103	96	72	58	48	41	36
	C	4	1.39	209	167	139	119	111	83	67	56	48	42
	M	5	1.55	233	186	155	133	124	93	74	62	53	47
	M	6	1.70	255	204	170	146	136	102	82	68	58	51
	M	7	1.83	275	220	183	157	146	110	88	73	63	55
035	UC	1	0.81	121	97	81	69	65	48	39	32	28	24
	EC	1.5	0.99	149	119	99	85	79	59	48	40	34	30
	VC	2	1.14	171	137	114	98	91	69	55	46	39	34
	C	3	1.40	210	168	140	120	112	84	67	56	48	42
	M	4	1.62	243	194	162	139	130	97	78	65	56	49
	M	5	1.81	272	217	181	155	145	109	87	72	62	54
	M	6	1.98	297	238	198	170	158	119	95	79	68	59
	M	7	2.14	321	257	214	183	171	128	103	86	73	64

Continued on Next Page

Secondary Nozzles

LOW-DRIFT AIR APPLICATION CHART - 50CM NOZZLE SPACING (CONTINUED)

TIP SIZE	ASABE DROPLET SIZE	PRESSURE (BAR)	FLOW RATE (LPM)	APPLICATION RATE L/HA - 50 CM SPACING KM/H									
				8	10	12	14	15	20	25	30	35	40
04	UC	1	0.92	139	111	92	79	74	55	44	37	32	28
	EC	1.5	1.13	170	136	113	97	90	68	54	45	39	34
	VC	2	1.31	196	157	131	112	104	78	63	52	45	39
	C	3	1.60	240	192	160	137	128	96	77	64	55	48
	M	4	1.85	278	222	185	159	148	111	89	74	63	56
	M	5	2.07	311	248	207	177	166	124	99	83	71	62
	M	6	2.26	339	271	226	194	181	136	108	90	77	68
	M	7	2.44	366	293	244	209	195	146	117	98	84	73
05	UC	1	1.16	173	139	116	99	92	69	55	46	40	35
	EC	1.5	1.41	212	170	141	121	113	85	68	57	48	42
	EC	2	1.63	245	196	163	140	131	98	78	65	56	49
	C	3	2.00	300	240	200	171	160	120	96	80	69	60
	C	4	2.31	347	277	231	198	185	139	111	92	79	69
	M	5	2.58	387	310	258	221	206	155	124	103	88	77
	M	6	2.83	425	340	283	243	226	170	136	113	97	85
	M	7	3.06	459	367	306	262	245	184	147	122	105	92

Secondary Nozzles

GUARDIAN™ (LDX) 120°

Guardian spray nozzles are ideal for insecticide and fungicide applications especially when used with suspension-based adjuvants. The Guardian's unique 20° inclined spray pattern allows users to aim the spray rearward for general spraying, forward for vertical targets or alternate nozzles to create a twin spray.

- Pre-orifice design for larger droplets than conventional flat fan
- Quick Change nozzle assembly includes tip and cap (one piece), gasket, and strainer for sizes 01-08, including 015 and 025



Guardian™ (LDX) 120° spray angle - ASABE droplet size classification chart									
Tip Size		015	02	025	03	04	05	06	08
Part Number		PSLDXQ20015	PSLDXQ2002	PSLDXQ20025	PSLDXQ2003	PSLDXQ2004	PSLDXQ2005	PSLDXQ2006	PSLDXQ2008
Pressure (Bar)	Pressure (PSI)								
1.0	15	M	M	M	M	C	C	VC	VC
1.4	20	M	M	M	M	C	C	VC	VC
2.0	30	F	M	M	M	C	C	C	C
2.8	40	F	M	M	M	C	C	C	C
3.4	50	F	M	M	M	M	M	C	C
4.1	60	F	M	M	M	M	M	C	C
4.8	70	F	F	F	M	M	M	M	M
5.5	80	F	F	F	M	M	M	M	M
6.2	90	F	F	F	M	M	M	M	M
6.9	100	F	F	F	F	M	M	M	M
7.9	115	F	F	F	F	M	M	M	M

Droplet data sourced at Pentair Hypro in a steady state condition per ASABE S572.3 Standard.

Features	
Common Use	Plant Health
Pattern	Tapered Flat Fan
Technology	Pre-Orifice
Material	Polycetal
Spray Angle	120°
Pressure Range	2.0 - 31 bar (30-45 PSI) (sizes 015-02)
	1.4 - 79 Bar (20-115 PSI) (sizes 025-08)
Configuration	Quick Change

ExactApply™ Compatibility	
15Hz PWM	Yes (aligned incline)
30Hz PWM	Yes (aligned or alternating incline)
AutoSelect A/B	Yes
Conventional	Yes

Service Parts	
Cap Gasket (EPDM)	PM200040-1
Cap Gasket (Viton)	PM200040V1

Secondary Nozzles

GUARDIAN™ APPLICATION CHART - 25CM NOZZLE SPACING

TIP SIZE	ASABE DROPLET SIZE	PRESSURE (BAR)	FLOW RATE (LPM)	APPLICATION RATE L/HA - 25 CM SPACING KM/H									
				8	10	12	14	15	20	25	30	35	40
015	M	1.5	0.42	126	101	84	72	67	50	40	34	29	25
	M	2	0.49	147	118	98	84	78	59	47	39	34	29
	M	3	0.60	180	144	120	103	96	72	58	48	41	36
	M	4	0.69	207	166	138	118	110	83	66	55	47	41
	F	5	0.77	231	185	154	132	123	92	74	62	53	46
	F	6	0.85	255	204	170	146	136	102	82	68	58	51
	F	7	0.92	276	221	184	158	147	110	88	74	63	55
	F	8	0.98	294	235	196	168	157	118	94	78	67	59
02	M	1.5	0.57	171	137	114	98	91	68	55	46	39	34
	M	2	0.65	195	156	130	111	104	78	62	52	45	39
	M	3	0.80	240	192	160	137	128	96	77	64	55	48
	M	4	0.92	276	221	184	158	147	110	88	74	63	55
	M	5	1.03	309	247	206	177	165	124	99	82	71	62
	M	6	1.13	339	271	226	194	181	136	108	90	77	68
	M	7	1.22	366	293	244	209	195	146	117	98	84	73
	F	8	1.31	393	314	262	225	210	157	126	105	90	79
025	M	1.5	0.71	213	170	142	122	114	85	68	57	49	43
	M	2	0.82	246	197	164	141	131	98	79	66	56	49
	M	3	1.00	300	240	200	171	160	120	96	80	69	60
	M	4	1.15	345	276	230	197	184	138	110	92	79	69
	M	5	1.29	387	310	258	221	206	155	124	103	88	77
	M	6	1.41	423	338	282	242	226	169	135	113	97	85
	M	7	1.53	459	367	306	262	245	184	147	122	105	92
	M	8	1.63	489	391	326	279	261	196	156	130	112	98
03	C	1.5	0.85	255	204	170	146	136	102	82	68	58	51
	M	2	0.98	294	235	196	168	157	118	94	78	67	59
	M	3	1.20	360	288	240	206	192	144	115	96	82	72
	M	4	1.39	417	334	278	238	222	167	133	111	95	83
	M	5	1.55	465	372	310	266	248	186	149	124	106	93
	M	6	1.70	510	408	340	291	272	204	163	136	117	102
	M	7	1.83	549	439	366	314	293	220	176	146	125	110
	M	8	1.96	588	470	392	336	314	235	188	157	134	118

Continued on Next Page

Secondary Nozzles

GUARDIAN™ APPLICATION CHART - 25CM NOZZLE SPACING (CONTINUED)

TIP SIZE	ASABE DROPLET SIZE	PRESSURE (BAR)	FLOW RATE (LPM)	APPLICATION RATE L/HA - 25 CM SPACING KM/H									
				8	10	12	14	15	20	25	30	35	40
04	VC	1.5	1.13	339	271	226	194	181	136	108	90	77	68
	VC	2	1.31	393	314	262	225	210	157	126	105	90	79
	C	3	1.60	480	384	320	274	256	192	154	128	110	96
	C	4	1.85	555	444	370	317	296	222	178	148	127	111
	M	5	2.07	621	497	414	355	331	248	199	166	142	124
	M	6	2.26	678	542	452	387	362	271	217	181	155	136
	M	7	2.44	732	586	488	418	390	293	234	195	167	146
	M	8	2.61	783	626	522	447	418	313	251	209	179	157
05	EC	1.5	1.41	423	338	282	242	226	169	135	113	97	85
	EC	2	1.63	489	391	326	279	261	196	156	130	112	98
	VC	3	2.00	600	480	400	343	320	240	192	160	137	120
	C	4	2.31	693	554	462	396	370	277	222	185	158	139
	M	5	2.58	774	619	516	442	413	310	248	206	177	155
	M	6	2.83	849	679	566	485	453	340	272	226	194	170
	M	7	3.06	918	734	612	525	490	367	294	245	210	184
	F	8	3.27	981	785	654	561	523	392	314	262	224	196
06	EC	1.5	1.70	510	408	340	291	272	204	163	136	117	102
	EC	2	1.96	588	470	392	336	314	235	188	157	134	118
	VC	3	2.40	720	576	480	411	384	288	230	192	165	144
	C	4	2.77	831	665	554	475	443	332	266	222	190	166
	M	5	3.10	930	744	620	531	496	372	298	248	213	186
	M	6	3.39	1017	814	678	581	542	407	325	271	232	203
	M	7	3.67	1101	881	734	629	587	440	352	294	252	220
	M	8	3.92	1176	941	784	672	627	470	376	314	269	235
08	EC	1.5	2.26	678	542	452	387	362	271	217	181	155	136
	VC	2	2.61	783	626	522	447	418	313	251	209	179	157
	C	3	3.20	960	768	640	549	512	384	307	256	219	192
	M	4	3.70	1110	888	740	634	592	444	355	296	254	222
	M	5	4.13	1239	991	826	708	661	496	396	330	283	248
	M	6	4.53	1359	1087	906	777	725	544	435	362	311	272
	F	7	4.89	1467	1174	978	838	782	587	469	391	335	293
	F	8	5.23	1569	1255	1046	897	837	628	502	418	359	314

Secondary Nozzles

GUARDIAN™ APPLICATION CHART - 38CM NOZZLE SPACING (CONTINUED)

TIP SIZE	ASABE DROPLET SIZE	PRESSURE (BAR)	FLOW RATE (LPM)	APPLICATION RATE L/HA - 38 CM SPACING KM/H									
				8	10	12	14	15	20	25	30	35	40
015	M	1.5	0.42	83	66	55	47	44	33	27	22	19	17
	M	2	0.49	97	77	64	55	52	39	31	26	22	19
	M	3	0.60	118	95	79	68	63	47	38	32	27	24
	M	4	0.69	136	109	91	78	73	54	44	36	31	27
	F	5	0.77	152	122	101	87	81	61	49	41	35	30
	F	6	0.85	168	134	112	96	89	67	54	45	38	34
	F	7	0.92	182	145	121	104	97	73	58	48	42	36
	F	8	0.98	193	155	129	111	103	77	62	52	44	39
02	M	1.5	0.57	113	90	75	64	60	45	36	30	26	23
	M	2	0.65	128	103	86	73	68	51	41	34	29	26
	M	3	0.80	158	126	105	90	84	63	51	42	36	32
	M	4	0.92	182	145	121	104	97	73	58	48	42	36
	M	5	1.03	203	163	136	116	108	81	65	54	46	41
	M	6	1.13	223	178	149	127	119	89	71	59	51	45
	M	7	1.22	241	193	161	138	128	96	77	64	55	48
	F	8	1.31	259	207	172	148	138	103	83	69	59	52
025	M	1.5	0.71	140	112	93	80	75	56	45	37	32	28
	M	2	0.82	162	129	108	92	86	65	52	43	37	32
	M	3	1.00	197	158	132	113	105	79	63	53	45	39
	M	4	1.15	227	182	151	130	121	91	73	61	52	45
	M	5	1.29	255	204	170	145	136	102	81	68	58	51
	M	6	1.41	278	223	186	159	148	111	89	74	64	56
	M	7	1.53	302	242	201	173	161	121	97	81	69	60
	M	8	1.63	322	257	214	184	172	129	103	86	74	64
03	C	1.5	0.85	168	134	112	96	89	67	54	45	38	34
	M	2	0.98	193	155	129	111	103	77	62	52	44	39
	M	3	1.20	237	189	158	135	126	95	76	63	54	47
	M	4	1.39	274	219	183	157	146	110	88	73	63	55
	M	5	1.55	306	245	204	175	163	122	98	82	70	61
	M	6	1.70	336	268	224	192	179	134	107	89	77	67
	M	7	1.83	361	289	241	206	193	144	116	96	83	72
	M	8	1.96	387	309	258	221	206	155	124	103	88	77

Continued on Next Page

Secondary Nozzles

GUARDIAN™ APPLICATION CHART - 38CM NOZZLE SPACING (CONTINUED)

TIP SIZE	ASABE DROPLET SIZE	PRESSURE (BAR)	FLOW RATE (LPM)	APPLICATION RATE L/HA - 38 CM SPACING KM/H									
				8	10	12	14	15	20	25	30	35	40
04	VC	1.5	1.13	223	178	149	127	119	89	71	59	51	45
	VC	2	1.31	259	207	172	148	138	103	83	69	59	52
	C	3	1.60	316	253	211	180	168	126	101	84	72	63
	C	4	1.85	365	292	243	209	195	146	117	97	83	73
	M	5	2.07	409	327	272	233	218	163	131	109	93	82
	M	6	2.26	446	357	297	255	238	178	143	119	102	89
	M	7	2.44	482	385	321	275	257	193	154	128	110	96
	M	8	2.61	515	412	343	294	275	206	165	137	118	103
05	EC	1.5	1.41	278	223	186	159	148	111	89	74	64	56
	EC	2	1.63	322	257	214	184	172	129	103	86	74	64
	VC	3	2.00	395	316	263	226	211	158	126	105	90	79
	C	4	2.31	456	365	304	261	243	182	146	122	104	91
	M	5	2.58	509	407	339	291	272	204	163	136	116	102
	M	6	2.83	559	447	372	319	298	223	179	149	128	112
	M	7	3.06	604	483	403	345	322	242	193	161	138	121
	F	8	3.27	645	516	430	369	344	258	207	172	148	129
06	EC	1.5	1.70	336	268	224	192	179	134	107	89	77	67
	EC	2	1.96	387	309	258	221	206	155	124	103	88	77
	VC	3	2.40	474	379	316	271	253	189	152	126	108	95
	C	4	2.77	547	437	364	312	292	219	175	146	125	109
	M	5	3.10	612	489	408	350	326	245	196	163	140	122
	M	6	3.39	669	535	446	382	357	268	214	178	153	134
	M	7	3.67	724	579	483	414	386	290	232	193	166	145
	M	8	3.92	774	619	516	442	413	309	248	206	177	155
08	EC	1.5	2.26	446	357	297	255	238	178	143	119	102	89
	VC	2	2.61	515	412	343	294	275	206	165	137	118	103
	C	3	3.20	632	505	421	361	337	253	202	168	144	126
	M	4	3.70	730	584	487	417	389	292	234	195	167	146
	M	5	4.13	815	652	543	466	435	326	261	217	186	163
	M	6	4.53	894	715	596	511	477	358	286	238	204	179
	F	7	4.89	965	772	643	552	515	386	309	257	221	193
	F	8	5.23	1032	826	688	590	551	413	330	275	236	206

Secondary Nozzles

GUARDIAN™ APPLICATION CHART - 50CM NOZZLE SPACING

TIP SIZE	ASABE DROPLET SIZE	PRESSURE (BAR)	FLOW RATE (LPM)	APPLICATION RATE L/HA - 50 CM SPACING KM/H									
				8	10	12	14	15	20	25	30	35	40
015	M	1.5	0.42	63	50	42	36	34	25	20	17	14	13
	M	2	0.49	74	59	49	42	39	29	24	20	17	15
	M	3	0.60	90	72	60	51	48	36	29	24	21	18
	M	4	0.69	104	83	69	59	55	41	33	28	24	21
	F	5	0.77	116	92	77	66	62	46	37	31	26	23
	F	6	0.85	128	102	85	73	68	51	41	34	29	26
	F	7	0.92	138	110	92	79	74	55	44	37	32	28
	F	8	0.98	147	118	98	84	78	59	47	39	34	29
02	M	1.5	0.57	86	68	57	49	46	34	27	23	20	17
	M	2	0.65	98	78	65	56	52	39	31	26	22	20
	M	3	0.80	120	96	80	69	64	48	38	32	27	24
	M	4	0.92	138	110	92	79	74	55	44	37	32	28
	M	5	1.03	155	124	103	88	82	62	49	41	35	31
	M	6	1.13	170	136	113	97	90	68	54	45	39	34
	M	7	1.22	183	146	122	105	98	73	59	49	42	37
	F	8	1.31	197	157	131	112	105	79	63	52	45	39
025	M	1.5	0.71	107	85	71	61	57	43	34	28	24	21
	M	2	0.82	123	98	82	70	66	49	39	33	28	25
	M	3	1.00	150	120	100	86	80	60	48	40	34	30
	M	4	1.15	173	138	115	99	92	69	55	46	39	35
	M	5	1.29	194	155	129	111	103	77	62	52	44	39
	M	6	1.41	212	169	141	121	113	85	68	56	48	42
	M	7	1.53	230	184	153	131	122	92	73	61	52	46
	M	8	1.63	245	196	163	140	130	98	78	65	56	49
03	C	1.5	0.85	128	102	85	73	68	51	41	34	29	26
	M	2	0.98	147	118	98	84	78	59	47	39	34	29
	M	3	1.20	180	144	120	103	96	72	58	48	41	36
	M	4	1.39	209	167	139	119	111	83	67	56	48	42
	M	5	1.55	233	186	155	133	124	93	74	62	53	47
	M	6	1.70	255	204	170	146	136	102	82	68	58	51
	M	7	1.83	275	220	183	157	146	110	88	73	63	55
	M	8	1.96	294	235	196	168	157	118	94	78	67	59

Continued on Next Page

Secondary Nozzles

GUARDIAN™ APPLICATION CHART - 50CM NOZZLE SPACING (CONTINUED)

TIP SIZE	ASABE DROPLET SIZE	PRESSURE (BAR)	FLOW RATE (LPM)	APPLICATION RATE L/HA - 50 CM SPACING KM/H									
				8	10	12	14	15	20	25	30	35	40
04	VC	1.5	1.13	170	136	113	97	90	68	54	45	39	34
	VC	2	1.31	197	157	131	112	105	79	63	52	45	39
	C	3	1.60	240	192	160	137	128	96	77	64	55	48
	C	4	1.85	278	222	185	159	148	111	89	74	63	56
	M	5	2.07	311	248	207	177	166	124	99	83	71	62
	M	6	2.26	339	271	226	194	181	136	108	90	77	68
	M	7	2.44	366	293	244	209	195	146	117	98	84	73
	M	8	2.61	392	313	261	224	209	157	125	104	89	78
05	EC	1.5	1.41	212	169	141	121	113	85	68	56	48	42
	EC	2	1.63	245	196	163	140	130	98	78	65	56	49
	VC	3	2.00	300	240	200	171	160	120	96	80	69	60
	C	4	2.31	347	277	231	198	185	139	111	92	79	69
	M	5	2.58	387	310	258	221	206	155	124	103	88	77
	M	6	2.83	425	340	283	243	226	170	136	113	97	85
	M	7	3.06	459	367	306	262	245	184	147	122	105	92
	F	8	3.27	491	392	327	280	262	196	157	131	112	98
06	EC	1.5	1.70	255	204	170	146	136	102	82	68	58	51
	EC	2	1.96	294	235	196	168	157	118	94	78	67	59
	VC	3	2.40	360	288	240	206	192	144	115	96	82	72
	C	4	2.77	416	332	277	237	222	166	133	111	95	83
	M	5	3.10	465	372	310	266	248	186	149	124	106	93
	M	6	3.39	509	407	339	291	271	203	163	136	116	102
	M	7	3.67	551	440	367	315	294	220	176	147	126	110
	M	8	3.92	588	470	392	336	314	235	188	157	134	118
08	EC	1.5	2.26	339	271	226	194	181	136	108	90	77	68
	VC	2	2.61	392	313	261	224	209	157	125	104	89	78
	C	3	3.20	480	384	320	274	256	192	154	128	110	96
	M	4	3.70	555	444	370	317	296	222	178	148	127	111
	M	5	4.13	620	496	413	354	330	248	198	165	142	124
	M	6	4.53	680	544	453	388	362	272	217	181	155	136
	F	7	4.89	734	587	489	419	391	293	235	196	168	147
	F	8	5.23	785	628	523	448	418	314	251	209	179	157

Secondary Nozzles

EXTENDED RANGE 80° & 110° (ER)



Extended Range (ER) nozzles maintain a consistent spray angle over a wide pressure range down to 15 PSI and are available in 80° and 110° versions to work with different boom heights.

- Maintains good spray distribution and makes larger droplets at low pressures
- Quick Change nozzle assembly includes tip, cap and gasket

Extended Range (ER) 80° spray angle - ASABE droplet size classification chart							
Tip size		015	02	03	04	05	06
Part Number		PSERQ80015	PSERQ8002	PSERQ8003	PSERQ8004	PSERQ8005	PSERQ8006
Tip Only Number		PSER80015	PSER8002	PSER8003	PSER8004	PSER8005	PSER8006
Cap Number		PS900015	PS90002	PS90003	PS90004	PS90005	PS90006
Pressure (Bar)	Pressure (PSI)						
1.0	15	M	M	M	C	C	C
1.4	20	M	M	M	M	C	C
2.0	30	F	F	M	M	M	C
2.8	40	F	F	F	M	M	C
3.4	50	F	F	F	M	M	M
4.1	60	F	F	F	F	M	M
4.8	70	F	F	F	F	F	M

Droplet data sourced at Pentair Hypro in a steady state condition per ASABE S572.3 Standard.

Extended Range (ER) 110° spray angle - ASABE droplet size classification chart											
Tip size		015	02	25	.3	.4	.5	.6	0.8	1.0	15
Part Number		PSERQ10015	PSERQ1002	PSERQ10025	PSERQ1003	PSERQ1004	PSERQ1005	PSERQ1006	PSERQ1008	PSERQ1010	PSERQ1015
Tip Only Number		PSER10015	PSER1002	PSER10025	PSER1003	PSER1004	PSER1005	PSER1006	PSER1008	PSER1010	PSER1015
Cap Number		PS900015	PS90002	PS900025	PS90003	PS90004	PS90005	PS90006	PS90008	PS90020	PS90020
Pressure (Bar)	Pressure (PSI)										
1.0	15	M	M	M	M	M	M	C	C	VC	VC
1.4	20	F	F	M	M	M	M	M	C	C	VC
2.0	30	F	F	F	F	M	M	M	M	C	VC
2.8	40	F	F	F	F	F	F	M	M	M	C
3.4	50	F	F	F	F	F	F	F	M	M	C
4.1	60	F	F	F	F	F	F	F	M	M	M
4.8	70	F	F	F	F	F	F	F	M	M	M

Droplet data sourced at Pentair Hypro in a steady state condition per ASABE S572.3 Standard.

Features	
Common Use	General
Pattern	Tapered Flat Fan
Technology	Elliptical Orifice
Material	Polyacetal
Spray Angle	80° & 110°
Pressure Range	2.0 - 4.8 Bar (30-70 PSI) (015-02)
	1.0 - 4.8 Bar (15-70 PSI) (025-15)
Configuration	Quick Change

ExactApply™ Compatibility	
15Hz PWM	Yes
30Hz PWM	Yes
AutoSelect A/B	Yes
Conventional	Yes

Secondary Nozzles

EXTENDED RANGE 80° & 110° APPLICATION CHART - 25CM NOZZLE SPACING

TIP SIZE	ASABE DROPLET SIZE	PRESSURE (BAR)	FLOW RATE (LPM)	APPLICATION RATE L/HA - 25 CM SPACING KM/H									
				8	10	12	14	15	20	25	30	35	40
015	F	1	0.35	104	83	69	59	55	42	33	28	24	21
	F	1.5	0.42	127	102	85	73	68	51	41	34	29	25
	F	2	0.49	147	118	98	84	78	59	47	39	34	29
	F	3	0.55	164	131	110	94	88	66	53	44	38	33
	F	4	0.60	180	144	120	103	96	72	58	48	41	36
	F	5	0.69	208	166	139	119	111	83	67	55	48	42
02	F	1	0.46	139	111	92	79	74	55	44	37	32	28
	F	1.5	0.57	170	136	113	97	91	68	54	45	39	34
	F	2	0.65	196	157	131	112	105	78	63	52	45	39
	F	3	0.73	219	175	146	125	117	88	70	58	50	44
	F	4	0.80	240	192	160	137	128	96	77	64	55	48
	F	5	0.92	277	222	185	158	148	111	89	74	63	55
025	M	1	0.58	173	139	115	99	92	69	55	46	40	35
	M	1.5	0.71	212	170	141	121	113	85	68	57	48	42
	F	2	0.82	245	196	163	140	131	98	78	65	56	49
	F	3	0.91	274	219	183	156	146	110	88	73	63	55
	F	4	1.00	300	240	200	171	160	120	96	80	69	60
	F	5	1.15	346	277	231	198	185	139	111	92	79	69
03	M	1	0.69	208	166	139	119	111	83	67	55	48	42
	M	1.5	0.85	255	204	170	146	136	102	82	68	58	51
	F	2	0.98	294	235	196	168	157	118	94	78	67	59
	F	3	1.10	329	263	219	188	175	131	105	88	75	66
	F	4	1.20	360	288	240	206	192	144	115	96	82	72
	F	5	1.39	416	333	277	238	222	166	133	111	95	83
035	M	1	0.81	242	194	162	139	129	97	78	65	55	48
	M	1.5	0.99	297	238	198	170	158	119	95	79	68	59
	M	2	1.14	343	274	229	196	183	137	110	91	78	69
	F	3	1.28	383	307	256	219	204	153	123	102	88	77
	F	4	1.40	420	336	280	240	224	168	134	112	96	84
	F	5	1.62	485	388	323	277	259	194	155	129	111	97
04	M	1	0.92	277	222	185	158	148	111	89	74	63	55
	M	1.5	1.13	339	271	226	194	181	136	109	90	78	68
	M	2	1.31	392	313	261	224	209	157	125	104	90	78
	F	3	1.46	438	351	292	250	234	175	140	117	100	88
	F	4	1.60	480	384	320	274	256	192	154	128	110	96
	F	5	1.85	554	444	370	317	296	222	177	148	127	111

Continued on Next Page

Secondary Nozzles

EXTENDED RANGE 80° & 110° APPLICATION CHART - 25CM NOZZLE SPACING (CONTINUED)

TIP SIZE	ASABE DROPLET SIZE	PRESSURE (BAR)	FLOW RATE (LPM)	APPLICATION RATE L/HA - 25 CM SPACING KM/H									
				8	10	12	14	15	20	25	30	35	40
05	M	1	1.16	347	277	231	198	185	139	111	92	79	69
	M	1.5	1.41	424	339	283	242	226	170	136	113	97	85
	M	2	1.63	490	392	327	280	261	196	157	131	112	98
	F	3	1.83	548	438	365	313	292	219	175	146	125	110
	F	4	2.00	600	480	400	343	320	240	192	160	137	120
	F	5	2.31	693	554	462	396	369	277	222	185	158	139
06	C	1	1.39	416	333	277	238	222	166	133	111	95	83
	M	1.5	1.70	509	407	339	291	272	204	163	136	116	102
	M	2	1.96	588	470	392	336	314	235	188	157	134	118
	M	3	2.19	657	526	438	376	351	263	210	175	150	131
	F	4	2.40	720	576	480	411	384	288	230	192	165	144
	F	5	2.77	831	665	554	475	443	333	266	222	190	166
08	C	1	1.85	554	443	370	317	296	222	177	148	127	111
	C	1.5	2.26	679	543	453	388	362	272	217	181	155	136
	M	2	2.61	784	627	523	448	418	314	251	209	179	157
	M	3	2.92	876	701	584	501	467	351	280	234	200	175
	M	4	3.20	960	768	640	549	512	384	307	256	219	192
	F	5	3.70	1109	887	739	633	591	443	355	296	253	222
10	C	1	2.31	693	554	462	396	370	277	222	185	158	139
	C	1.5	2.83	849	679	566	485	453	340	272	226	194	170
	M	2	3.27	981	785	654	561	523	392	314	262	224	196
	M	3	4.00	1200	960	800	686	640	480	384	320	274	240
	M	4	4.62	1386	1109	924	792	739	554	444	370	317	277
	F	5	5.16	1548	1238	1032	885	826	619	495	413	354	310
15	VC	1	3.46	1038	830	692	593	554	415	332	277	237	208
	C	1.5	4.24	1272	1018	848	727	678	509	407	339	291	254
	C	2	4.90	1470	1176	980	840	784	588	470	392	336	294
	M	3	6.00	1800	1440	1200	1029	960	720	576	480	411	360
	M	4	6.93	2079	1663	1386	1188	1109	832	665	554	475	416
	M	5	7.75	2325	1860	1550	1329	1240	930	744	620	531	465

Secondary Nozzles

EXTENDED RANGE 80° & 110° APPLICATION CHART - 38CM NOZZLE SPACING

TIP SIZE	ASABE DROPLET SIZE	PRESSURE (BAR)	FLOW RATE (LPM)	APPLICATION RATE L/HA - 38 CM SPACING KM/H									
				8	10	12	14	15	20	25	30	35	40
015	F	1	0.35	68	55	46	39	36	27	22	18	16	14
	F	1.5	0.42	84	67	56	48	45	33	27	22	19	17
	F	2	0.49	97	77	64	55	52	39	31	26	22	19
	F	3	0.55	108	86	72	62	58	43	35	29	25	22
	F	4	0.60	118	95	79	68	63	47	38	32	27	24
	F	5	0.69	137	109	91	78	73	55	44	36	31	27
02	F	1	0.46	91	73	61	52	49	36	29	24	21	18
	F	1.5	0.57	112	89	74	64	60	45	36	30	26	22
	F	2	0.65	129	103	86	74	69	52	41	34	29	26
	F	3	0.73	144	115	96	82	77	58	46	38	33	29
	F	4	0.80	158	126	105	90	84	63	51	42	36	32
	F	5	0.92	182	146	122	104	97	73	58	49	42	36
025	M	1	0.58	114	91	76	65	61	46	36	30	26	23
	M	1.5	0.71	140	112	93	80	74	56	45	37	32	28
	F	2	0.82	161	129	107	92	86	64	52	43	37	32
	F	3	0.91	180	144	120	103	96	72	58	48	41	36
	F	4	1.00	197	158	132	113	105	79	63	53	45	39
	F	5	1.15	228	182	152	130	122	91	73	61	52	46
03	M	1	0.69	137	109	91	78	73	55	44	36	31	27
	M	1.5	0.85	168	134	112	96	89	67	54	45	38	34
	F	2	0.98	193	155	129	111	103	77	62	52	44	39
	F	3	1.10	216	173	144	123	115	86	69	58	49	43
	F	4	1.20	237	189	158	135	126	95	76	63	54	47
	F	5	1.39	274	219	182	156	146	109	88	73	63	55
035	M	1	0.81	159	128	106	91	85	64	51	43	36	32
	M	1.5	0.99	195	156	130	112	104	78	63	52	45	39
	M	2	1.14	226	180	150	129	120	90	72	60	52	45
	F	3	1.28	252	202	168	144	135	101	81	67	58	50
	F	4	1.40	276	221	184	158	147	111	88	74	63	55
	F	5	1.62	319	255	213	182	170	128	102	85	73	64
04	M	1	0.92	182	146	122	104	97	73	58	49	42	36
	M	1.5	1.13	223	179	149	128	119	89	71	60	51	45
	M	2	1.31	258	206	172	147	137	103	82	69	59	52
	F	3	1.46	288	231	192	165	154	115	92	77	66	58
	F	4	1.60	316	253	211	180	168	126	101	84	72	63
	F	5	1.85	365	292	243	208	195	146	117	97	83	73

Continued on Next Page

Secondary Nozzles

EXTENDED RANGE 80° & 110° APPLICATION CHART - 38CM NOZZLE SPACING (CONTINUED)

TIP SIZE	ASABE DROPLET SIZE	PRESSURE (BAR)	FLOW RATE (LPM)	APPLICATION RATE L/HA - 38 CM SPACING KM/H									
				8	10	12	14	15	20	25	30	35	40
05	M	1	1.16	228	182	152	130	122	91	73	61	52	46
	M	1.5	1.41	279	223	186	159	149	112	89	74	64	56
	M	2	1.63	322	258	215	184	172	129	103	86	74	64
	F	3	1.83	360	288	240	206	192	144	115	96	82	72
	F	4	2.00	395	316	263	226	211	158	126	105	90	79
	F	5	2.31	456	365	304	260	243	182	146	122	104	91
06	C	1	1.39	274	219	182	156	146	109	88	73	63	55
	M	1.5	1.70	335	268	223	191	179	134	107	89	77	67
	M	2	1.96	387	309	258	221	206	155	124	103	88	77
	M	3	2.19	432	346	288	247	231	173	138	115	99	86
	F	4	2.40	474	379	316	271	253	189	152	126	108	95
	F	5	2.77	547	438	365	313	292	219	175	146	125	109
08	C	1	1.85	365	292	243	208	194	146	117	97	83	73
	C	1.5	2.26	447	357	298	255	238	179	143	119	102	89
	M	2	2.61	516	413	344	295	275	206	165	138	118	103
	M	3	2.92	577	461	384	329	307	231	184	154	132	115
	M	4	3.20	632	505	421	361	337	253	202	168	144	126
	F	5	3.70	729	583	486	417	389	292	233	194	167	146
10	C	1	2.31	456	365	304	261	243	182	146	122	104	91
	C	1.5	2.83	559	447	372	319	298	223	179	149	128	112
	M	2	3.27	645	516	430	369	344	258	207	172	148	129
	M	3	4.00	789	632	526	451	421	316	253	211	180	158
	M	4	4.62	912	729	608	521	486	365	292	243	208	182
	F	5	5.16	1018	815	679	582	543	407	326	272	233	204
15	VC	1	3.46	683	546	455	390	364	273	219	182	156	137
	C	1.5	4.24	837	669	558	478	446	335	268	223	191	167
	C	2	4.90	967	774	645	553	516	387	309	258	221	193
	M	3	6.00	1184	947	789	677	632	474	379	316	271	237
	M	4	6.93	1368	1094	912	782	729	547	438	365	313	274
	M	5	7.75	1530	1224	1020	874	816	612	489	408	350	306

Secondary Nozzles

EXTENDED RANGE 80° & 110° APPLICATION CHART - 50CM NOZZLE SPACING

TIP SIZE	ASABE DROPLET SIZE	PRESSURE (BAR)	FLOW RATE (LPM)	APPLICATION RATE L/HA - 50 CM SPACING KM/H									
				8	10	12	14	15	20	25	30	35	40
015	F	1	0.35	52	42	35	30	28	21	17	14	12	10
	F	1.5	0.42	64	51	42	36	34	25	20	17	15	13
	F	2	0.49	73	59	49	42	39	29	24	20	17	15
	F	3	0.55	82	66	55	47	44	33	26	22	19	16
	F	4	0.60	90	72	60	51	48	36	29	24	21	18
	F	5	0.69	104	83	69	59	55	42	33	28	24	21
02	F	1	0.46	69	55	46	40	37	28	22	18	16	14
	F	1.5	0.57	85	68	57	48	45	34	27	23	19	17
	F	2	0.65	98	78	65	56	52	39	31	26	22	20
	F	3	0.73	110	88	73	63	58	44	35	29	25	22
	F	4	0.80	120	96	80	69	64	48	38	32	27	24
	F	5	0.92	139	111	92	79	74	55	44	37	32	28
025	M	1	0.58	87	69	58	49	46	35	28	23	20	17
	M	1.5	0.71	106	85	71	61	57	42	34	28	24	21
	F	2	0.82	122	98	82	70	65	49	39	33	28	24
	F	3	0.91	137	110	91	78	73	55	44	37	31	27
	F	4	1.00	150	120	100	86	80	60	48	40	34	30
	F	5	1.15	173	139	115	99	92	69	55	46	40	35
03	M	1	0.69	104	83	69	59	55	42	33	28	24	21
	M	1.5	0.85	127	102	85	73	68	51	41	34	29	25
	F	2	0.98	147	118	98	84	78	59	47	39	34	29
	F	3	1.10	164	131	110	94	88	66	53	44	38	33
	F	4	1.20	180	144	120	103	96	72	58	48	41	36
	F	5	1.39	208	166	139	119	111	83	67	55	48	42
035	M	1	0.81	121	97	81	69	65	48	39	32	28	24
	M	1.5	0.99	149	119	99	85	79	59	48	40	34	30
	M	2	1.14	171	137	114	98	91	69	55	46	39	34
	F	3	1.28	192	153	128	110	102	77	61	51	44	38
	F	4	1.40	210	168	140	120	112	84	67	56	48	42
	F	5	1.62	243	194	162	139	129	97	78	65	55	49
04	M	1	0.92	139	111	92	79	74	55	44	37	32	28
	M	1.5	1.13	170	136	113	97	90	68	54	45	39	34
	M	2	1.31	196	157	131	112	104	78	63	52	45	39
	F	3	1.46	219	175	146	125	117	88	70	58	50	44
	F	4	1.60	240	192	160	137	128	96	77	64	55	48
	F	5	1.85	277	222	185	158	148	111	89	74	63	55

Continued on Next Page

Secondary Nozzles

EXTENDED RANGE 80° & 110° APPLICATION CHART - 50CM NOZZLE SPACING (CONTINUED)

TIP SIZE	ASABE DROPLET SIZE	PRESSURE (BAR)	FLOW RATE (LPM)	APPLICATION RATE L/HA - 50 CM SPACING KM/H									
				8	10	12	14	15	20	25	30	35	40
05	M	1	1.16	173	139	116	99	92	69	55	46	40	35
	M	1.5	1.41	212	170	141	121	113	85	68	57	48	42
	M	2	1.63	245	196	163	140	131	98	78	65	56	49
	F	3	1.83	274	219	183	157	146	110	88	73	63	55
	F	4	2.00	300	240	200	171	160	120	96	80	69	60
	F	5	2.31	346	277	231	198	185	139	111	92	79	69
06	C	1	1.39	208	166	139	119	111	83	67	55	48	42
	M	1.5	1.70	255	204	170	145	136	102	81	68	58	51
	M	2	1.96	294	235	196	168	157	118	94	78	67	59
	M	3	2.19	329	263	219	188	175	131	105	88	75	66
	F	4	2.40	360	288	240	206	192	144	115	96	82	72
	F	5	2.77	416	333	277	238	222	166	133	111	95	83
08	C	1	1.85	277	222	185	158	148	111	89	74	63	55
	C	1.5	2.26	339	272	226	194	181	136	109	91	78	68
	M	2	2.61	392	314	261	224	209	157	125	105	90	78
	M	3	2.92	438	351	292	250	234	175	140	117	100	88
	M	4	3.20	480	384	320	274	256	192	154	128	110	96
	F	5	3.70	554	443	370	317	296	222	177	148	127	111
10	C	1	2.31	347	277	231	198	185	139	111	92	79	69
	C	1.5	2.83	425	340	283	243	226	170	136	113	97	85
	M	2	3.27	491	392	327	280	262	196	157	131	112	98
	M	3	4.00	600	480	400	343	320	240	192	160	137	120
	M	4	4.62	693	554	462	396	370	277	222	185	158	139
	F	5	5.16	774	619	516	442	413	310	248	206	177	155
15	VC	1	3.46	519	415	346	297	277	208	166	138	119	104
	C	1.5	4.24	636	509	424	363	339	254	204	170	145	127
	C	2	4.90	735	588	490	420	392	294	235	196	168	147
	M	3	6.00	900	720	600	514	480	360	288	240	206	180
	M	4	6.93	1040	832	693	594	554	416	333	277	238	208
	M	5	7.75	1163	930	775	664	620	465	372	310	266	233

Secondary Nozzles

LOW-DRIFT 110° (LD)

The Low-drift (LD) is the original drift-reducing tip. The special two-part construction includes a pre-orifice that reduces the number of drift-prone droplets.

- Significantly reduces spray drift, widening the operational window
- Balanced droplet size for effective, on-target spray



Low-drift (LD) 110° spray angle - ASABE droplet size classification chart									
Tip size		015	02	025	03	04	05	06	08
Tip Number		PSLD10015	PSLD1002	PSLD10025	PSLD1003	PSLD1004	PSLD1005	PSLD1006	PSLD1008
Cap Number		PS900015	PS90002	PS900025	PS90003	PS90004	PS90005	PS90006	PS90008
Pressure (Bar)	Pressure (PSI)								
1.0	15	M	C	C	C	C	C	VC	VC
1.4	20	M	M	M	C	C	C	VC	VC
2.0	30	M	M	M	C	C	C	C	C
2.8	40	M	M	M	M	M	C	C	C
3.4	50	M	M	M	M	M	C	C	C
4.1	60	M	M	M	M	M	M	C	C
4.8	70	F	M	M	M	M	M	M	C

Droplet data sourced at Pentair Hypro in a steady state condition per ASABE S572.3 Standard.

Features	
Common Use	Plant Health
Pattern	Tapered Flat Fan
Technology	Pre-orifice
Material	Polycetal
Spray Angle	110°
Pressure Range	1.0 - 4.8 Bar (15-70 PSI)
Configuration	Tip

ExactApply™ compatibility	
15Hz PWM	Yes
30Hz PWM	Yes
AutoSelect A/B	Yes
Conventional	Yes

Secondary Nozzles

LOW-DRIFT 110° APPLICATION CHART - 25CM NOZZLE SPACING

TIP SIZE	ASABE DROPLET SIZE	PRESSURE (BAR)	FLOW RATE (LPM)	APPLICATION RATE L/HA - 25 CM SPACING KM/H									
				8	10	12	14	15	20	25	30	35	40
015	M	1	0.35	104	83	69	59	55	42	33	28	24	21
	M	1.5	0.42	127	102	85	73	68	51	41	34	29	25
	M	2	0.49	147	118	98	84	78	59	47	39	34	29
	M	3	0.60	180	144	120	103	96	72	58	48	41	36
	M	4	0.69	207	166	138	118	110	83	66	55	47	41
	F	5	0.77	231	185	154	132	123	92	74	62	53	46
02	C	1	0.46	139	111	92	79	74	55	44	37	32	28
	M	1.5	0.57	170	136	113	97	91	68	54	45	39	34
	M	2	0.65	196	157	131	112	105	78	63	52	45	39
	M	3	0.80	240	192	160	137	128	96	77	64	55	48
	M	4	0.92	276	221	184	158	147	110	88	74	63	55
	M	5	1.03	309	247	206	177	165	124	99	82	71	62
025	C	1	0.58	173	139	115	99	92	69	55	46	40	35
	M	1.5	0.71	212	170	141	121	113	85	68	57	48	42
	M	2	0.82	245	196	163	140	131	98	78	65	56	49
	M	3	1.00	300	240	200	171	160	120	96	80	69	60
	M	4	1.15	345	276	230	197	184	138	110	92	79	69
	M	5	1.29	387	310	258	221	206	155	124	103	88	77
03	C	1	0.69	208	166	139	119	111	83	67	55	48	42
	C	1.5	0.85	255	204	170	146	136	102	82	68	58	51
	C	2	0.98	294	235	196	168	157	118	94	78	67	59
	M	3	1.20	360	288	240	206	192	144	115	96	82	72
	M	4	1.39	417	334	278	238	222	167	133	111	95	83
	M	5	1.55	465	372	310	266	248	186	149	124	106	93
04	C	1	0.92	277	222	185	158	148	111	89	74	63	55
	C	1.5	1.13	339	271	226	194	181	136	109	90	78	68
	C	2	1.31	392	313	261	224	209	157	125	104	90	78
	M	3	1.60	480	384	320	274	256	192	154	128	110	96
	M	4	1.85	555	444	370	317	296	222	178	148	127	111
	M	5	2.07	621	497	414	355	331	248	199	166	142	124
05	C	1	1.16	347	277	231	198	185	139	111	92	79	69
	C	1.5	1.41	424	339	283	242	226	170	136	113	97	85
	C	2	1.63	490	392	327	280	261	196	157	131	112	98
	C	3	2.00	600	480	400	343	320	240	192	160	137	120
	M	4	2.31	693	554	462	396	370	277	222	185	158	139
	M	5	2.58	774	619	516	442	413	310	248	206	177	155
06	VC	1	1.39	416	333	277	238	222	166	133	111	95	83
	C	1.5	1.70	509	407	339	291	272	204	163	136	116	102
	C	2	1.96	588	470	392	336	314	235	188	157	134	118
	C	3	2.40	720	576	480	411	384	288	230	192	165	144
	C	4	2.77	831	665	554	475	443	332	266	222	190	166
	M	5	3.10	930	744	620	531	496	372	298	248	213	186
08	VC	1	1.85	554	443	370	317	296	222	177	148	127	111
	C	1.5	2.26	679	543	453	388	362	272	217	181	155	136
	C	2	2.61	784	627	523	448	418	314	251	209	179	157
	C	3	3.20	960	768	640	549	512	384	307	256	219	192
	C	4	3.70	1110	888	740	634	592	444	355	296	254	222
	C	5	4.13	1239	991	826	708	661	496	396	330	283	248

Secondary Nozzles

LOW-DRIFT 110° APPLICATION CHART - 38CM NOZZLE SPACING

TIP SIZE	ASABE DROPLET SIZE	PRESSURE (BAR)	FLOW RATE (LPM)	APPLICATION RATE L/HA - 38 CM SPACING KM/H									
				8	10	12	14	15	20	25	30	35	40
015	M	1	0.35	68	55	46	39	36	27	22	18	16	14
	M	1.5	0.42	84	67	56	48	45	33	27	22	19	17
	M	2	0.49	97	77	64	55	52	39	31	26	22	19
	M	3	0.60	118	95	79	68	63	47	38	32	27	24
	M	4	0.69	136	109	91	78	73	54	44	36	31	27
	F	5	0.77	152	122	101	87	81	61	49	41	35	30
02	C	1	0.46	91	73	61	52	49	36	29	24	21	18
	M	1.5	0.57	112	89	74	64	60	45	36	30	26	22
	M	2	0.65	129	103	86	74	69	52	41	34	29	26
	M	3	0.80	158	126	105	90	84	63	51	42	36	32
	M	4	0.92	182	145	121	104	97	73	58	48	42	36
	M	5	1.03	203	163	136	116	108	81	65	54	46	41
025	C	1	0.58	114	91	76	65	61	46	36	30	26	23
	M	1.5	0.71	140	112	93	80	74	56	45	37	32	28
	M	2	0.82	161	129	107	92	86	64	52	43	37	32
	M	3	1.00	197	158	132	113	105	79	63	53	45	39
	M	4	1.15	227	182	151	130	121	91	73	61	52	45
	M	5	1.29	255	204	170	145	136	102	81	68	58	51
03	C	1	0.69	137	109	91	78	73	55	44	36	31	27
	C	1.5	0.85	168	134	112	96	89	67	54	45	38	34
	C	2	0.98	193	155	129	111	103	77	62	52	44	39
	M	3	1.20	237	189	158	135	126	95	76	63	54	47
	M	4	1.39	274	219	183	157	146	110	88	73	63	55
	M	5	1.55	306	245	204	175	163	122	98	82	70	61
04	C	1	0.92	182	146	122	104	97	73	58	49	42	36
	C	1.5	1.13	223	179	149	128	119	89	71	60	51	45
	C	2	1.31	258	206	172	147	137	103	82	69	59	52
	M	3	1.60	316	253	211	180	168	126	101	84	72	63
	M	4	1.85	365	292	243	209	195	146	117	97	83	73
	M	5	2.07	409	327	272	233	218	163	131	109	93	82
05	C	1	1.16	228	182	152	130	122	91	73	61	52	46
	C	1.5	1.41	279	223	186	159	149	112	89	74	64	56
	C	2	1.63	322	258	215	184	172	129	103	86	74	64
	C	3	2.00	395	316	263	226	211	158	126	105	90	79
	M	4	2.31	456	365	304	261	243	182	146	122	104	91
	M	5	2.58	509	407	339	291	272	204	163	136	116	102
06	VC	1	1.39	274	219	182	156	146	109	88	73	63	55
	C	1.5	1.70	335	268	223	191	179	134	107	89	77	67
	C	2	1.96	387	309	258	221	206	155	124	103	88	77
	C	3	2.40	474	379	316	271	253	189	152	126	108	95
	C	4	2.77	547	437	364	312	292	219	175	146	125	109
	M	5	3.10	612	489	408	350	326	245	196	163	140	122
08	VC	1	1.85	365	292	243	208	194	146	117	97	83	73
	C	1.5	2.26	447	357	298	255	238	179	143	119	102	89
	C	2	2.61	516	413	344	295	275	206	165	138	118	103
	C	3	3.20	632	505	421	361	337	253	202	168	144	126
	C	4	3.70	730	584	487	417	389	292	234	195	167	146
	C	5	4.13	815	652	543	466	435	326	261	217	186	163

Secondary Nozzles

LOW-DRIFT 110° APPLICATION CHART - 50CM NOZZLE SPACING

TIP SIZE	ASABE DROPLET SIZE	PRESSURE (BAR)	FLOW RATE (LPM)	APPLICATION RATE L/HA - 50 CM SPACING KM/H									
				8	10	12	14	15	20	25	30	35	40
015	M	1	0.35	52	42	35	30	28	21	17	14	12	10
	M	1.5	0.42	64	51	42	36	34	25	20	17	15	13
	M	2	0.49	73	59	49	42	39	29	24	20	17	15
	M	3	0.60	90	72	60	51	48	36	29	24	21	18
	M	4	0.69	104	83	69	59	55	41	33	28	24	21
	F	5	0.77	116	92	77	66	62	46	37	31	26	23
02	C	1	0.46	69	55	46	40	37	28	22	18	16	14
	M	1.5	0.57	85	68	57	48	45	34	27	23	19	17
	M	2	0.65	98	78	65	56	52	39	31	26	22	20
	M	3	0.80	120	96	80	69	64	48	38	32	27	24
	M	4	0.92	138	110	92	79	74	55	44	37	32	28
	M	5	1.03	155	124	103	88	82	62	49	41	35	31
025	C	1	0.58	87	69	58	49	46	35	28	23	20	17
	M	1.5	0.71	106	85	71	61	57	42	34	28	24	21
	M	2	0.82	122	98	82	70	65	49	39	33	28	24
	M	3	1.00	150	120	100	86	80	60	48	40	34	30
	M	4	1.15	173	138	115	99	92	69	55	46	39	35
	M	5	1.29	194	155	129	111	103	77	62	52	44	39
03	C	1	0.69	104	83	69	59	55	42	33	28	24	21
	C	1.5	0.85	127	102	85	73	68	51	41	34	29	25
	C	2	0.98	147	118	98	84	78	59	47	39	34	29
	M	3	1.20	180	144	120	103	96	72	58	48	41	36
	M	4	1.39	209	167	139	119	111	83	67	56	48	42
	M	5	1.55	233	186	155	133	124	93	74	62	53	47
04	C	1	0.92	139	111	92	79	74	55	44	37	32	28
	C	1.5	1.13	170	136	113	97	90	68	54	45	39	34
	C	2	1.31	196	157	131	112	104	78	63	52	45	39
	M	3	1.60	240	192	160	137	128	96	77	64	55	48
	M	4	1.85	278	222	185	159	148	111	89	74	63	56
	M	5	2.07	311	248	207	177	166	124	99	83	71	62
05	C	1	1.16	173	139	116	99	92	69	55	46	40	35
	C	1.5	1.41	212	170	141	121	113	85	68	57	48	42
	C	2	1.63	245	196	163	140	131	98	78	65	56	49
	C	3	2.00	300	240	200	171	160	120	96	80	69	60
	M	4	2.31	347	277	231	198	185	139	111	92	79	69
	M	5	2.58	387	310	258	221	206	155	124	103	88	77
06	VC	1	1.39	208	166	139	119	111	83	67	55	48	42
	C	1.5	1.70	255	204	170	145	136	102	81	68	58	51
	C	2	1.96	294	235	196	168	157	118	94	78	67	59
	C	3	2.40	360	288	240	206	192	144	115	96	82	72
	C	4	2.77	416	332	277	237	222	166	133	111	95	83
	M	5	3.10	465	372	310	266	248	186	149	124	106	93
08	VC	1	1.85	277	222	185	158	148	111	89	74	63	55
	C	1.5	2.26	339	272	226	194	181	136	109	91	78	68
	C	2	2.61	392	314	261	224	209	157	125	105	90	78
	C	3	3.20	480	384	320	274	256	192	154	128	110	96
	C	4	3.70	555	444	370	317	296	222	178	148	127	111
	C	5	4.13	620	496	413	354	330	248	198	165	142	124

Secondary Nozzles

FLOOD 80°- 160° (FL)

The Flood (FL) wide-angle fan tip creates a wide pattern at very low pressures while creating mainly medium and coarse droplets. It is well suited for mounting on machinery where a wide angle or a low spray height is desired and on sprayers using very low pressures, including manual sprayers.

- Sprays at very low pressures
- Medium to coarse spray is suited for a variety of applications
- Larger sizes are suitable for liquid fertilizer applications



Flood (FL) 80°-160° spray angle - ASABE droplet size classification chart										
Tip size		.20	.25	.30	.40	.50	.75	1.5	2.0	
Tip Number		PSFL2	PSFL025	PSFL3	PSFL4	PSFL5	PSFL75	PSFL15	PSFL20	
Cap Number		PS90404	PS90405	PS90406	PS90408	PS90420	PS90420	PS90420	PS90420	
Pressure (Bar)	Pressure (PSI)									
1.0	10	C	C	C	VC	C	C	XC	UC	
1.4	20	M	M	M	M	M	C	XC	UC	
2.0	30	M	M	M	M	M	C	VC	XC	
2.8	40	M	M	M	M	M	C	VC	XC	
3.4	50	M	F	M	M	M	C	VC	XC	
4.1	60	F	F	M	M	M	M	VC	XC	

Droplet data sourced at Pentair Hypro in a steady state condition per ASABE S572.3 Standard.

Features	
Common Use	Weeds & Fertilizer
Pattern	Flood
Technology	Deflection
Material	Polyacetal
Spray Angle	80° - 160°
Pressure Range	1.0 - 4.1 Bar (10-60 PSI)
Configuration	Tip

ExactApply™ compatibility	
15Hz PWM	No
30Hz PWM	No
AutoSelect A/B	Yes
Conventional	Yes

DISC (D)

Disc

The Disc (D) regulates flow and produces a straight stream pattern. Precision-moulded in polyacetal.



Disc	Litres/min									
	Bar									
	1	2	3	4	5	6	7	8	9	10
PSD01	0.260	0.370	0.450	0.520	0.580	0.640	0.690	0.730	0.780	0.820
PSD015	0.360	0.510	0.620	0.720	0.800	0.880	0.950	1.010	1.070	1.130
PSD02	0.480	0.680	0.830	0.960	1.070	1.170	1.270	1.360	1.440	1.520
PSD03	0.610	0.860	1.050	1.210	1.360	1.480	1.600	1.710	1.820	1.920
PSD04	1.100	1.560	1.910	2.210	2.470	2.700	2.920	3.120	3.310	3.490
PSD05	1.790	2.530	3.100	3.580	4.000	4.380	4.740	5.060	5.37	5.66
PSD06	2.610	3.690	4.520	5.220	5.840	6.39	6.90	7.38	7.83	8.25
PSD07	3.390	4.940	6.05	6.99	7.81	8.56	9.24	9.88	10.48	11.05
PSD08	4.390	6.21	7.60	8.78	9.81	10.75	11.61	12.41	13.16	13.88
PSD10	7.35	10.39	12.73	14.70	16.43	18.00	19.45	20.79	22.05	23.24
PSD12	9.93	14.04	17.20	19.86	22.21	24.32	26.27	28.09	29.79	31.40

Features	
Common Use	Fertilizer
Pattern	Stream
Technology	Round Orifice
Material	Polyacetal
Spray Angle	0°
Pressure Range	1.0 - 10 Bar (10-150 PSI)
Configuration	Disc

Application Selection Guide	
Foliar Contact	-
Foliar Systemic	-
Soil Applied	Very Good
Material	Polyacetal

Part Numbers	
Tips	
	PSD01
	PSD015
	PSD02
	PSD03
	PSD04
	PSD05
	PSD06
	PSD07
	PSD08
	PSD10
	PSD12

Secondary Nozzles

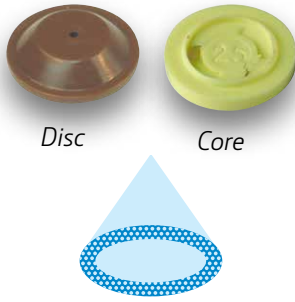

HOLLOW CONE SPRAY – DISC & CORES 25°-110°

The disc and core hollow-cone spray tips produce finely atomized droplets in a hollow-cone pattern in a variety of spray pattern widths.

Disc	Core	Spray Angle		Flow Rate							
		at	Disc/Core Colour	L/min							
				Bar							
		3 Bar		1	2	3	4	5	6	8	10
PSD01	PSC13	50	Gray/Red	0.16	0.22	0.27	0.31	0.35	0.38	0.44	0.49
PSD015	PSC13	55	Black/Red	0.17	0.24	0.29	0.33	0.37	0.41	0.47	0.53
PSD02	PSC13	65	Brown/Red	0.18	0.26	0.32	0.37	0.41	0.45	0.52	0.58
PSD03	PSC13	70	Orange/Red	0.21	0.29	0.36	0.42	0.46	0.51	0.59	0.66
PSD04	PSC13	80	Red/Red	0.27	0.38	0.47	0.54	0.61	0.66	0.77	0.86
PSD01	PSC23	45	Gray/LightBlue	0.16	0.23	0.28	0.32	0.36	0.40	0.46	0.51
PSD015	PSC23	50	Black/Light Blue	0.21	0.29	0.36	0.42	0.46	0.51	0.59	0.66
PSD02	PSC23	70	Brown/LightBlue	0.23	0.32	0.39	0.45	0.50	0.55	0.64	0.71
PSD03	PSC23	70	Orange/Light Blue	0.27	0.38	0.47	0.54	0.61	0.66	0.77	0.86
PSD04	PSC23	80	Red/LightBlue	0.34	0.48	0.59	0.68	0.76	0.83	0.96	1.08
PSD05	PSC23	90	Blue/LightBlue	0.41	0.58	0.71	0.82	0.92	1.00	1.16	1.30
PSD06	PSC23	90	Yellow/LightBlue	0.48	0.68	0.83	0.96	1.07	1.17	1.36	1.52
PSD01	PSC25	25	Gray/Yellow	0.23	0.33	0.40	0.46	0.52	0.57	0.65	0.73
PSD015	PSC25	40	Black/Yellow	0.30	0.42	0.52	0.60	0.67	0.74	0.85	0.95
PSD02	PSC25	50	Brown/Yellow	0.36	0.51	0.63	0.73	0.81	0.89	1.03	1.15
PSD03	PSC25	60	Orange/Yellow	0.43	0.61	0.75	0.87	0.97	1.06	1.22	1.37
PSD04	PSC25	75	Red/Yellow	0.66	0.93	1.14	1.32	1.47	1.61	1.86	2.08
PSD05	PSC25	80	Blue/Yellow	0.80	1.13	1.38	1.59	1.78	1.95	2.25	2.52
PSD06	PSC25	85	Yellow/Yellow	1.00	1.42	1.74	2.01	2.25	2.46	2.84	3.18
PSD07	PSC25	90	Green/Yellow	1.18	1.67	2.05	2.37	2.65	2.90	3.36	3.74
PSD08	PSC25	95	White/Yellow	1.39	1.97	2.41	2.78	3.11	3.41	3.94	4.40
PSD10	PSC25	100	LimeGreen/Yellow	1.73	2.45	3.00	3.46	3.87	4.24	4.90	5.48
PSD12	PSC25	110	RoyalBlue/Yellow	2.12	3.00	3.67	4.24	4.74	5.19	5.99	6.70
PSD01	PSC45	25	Gray/Green	0.280	0.39	0.48	0.55	0.62	0.68	0.78	0.88
PSD015	PSC45	35	Black/Green	0.37	0.52	0.64	0.74	0.83	0.91	1.05	1.17
PSD02	PSC45	45	Brown/Green	0.46	0.65	0.80	0.92	1.03	1.13	1.31	1.46
PSD03	PSC45	55	Orange/Green	0.53	0.74	0.91	1.05	1.17	1.29	1.49	1.66
PSD04	PSC45	70	Red/Green	0.82	1.16	1.42	1.64	1.83	2.01	2.32	2.59
PSD05	PSC45	75	Blue/Green	1.03	1.45	1.78	2.06	2.30	2.52	2.91	3.25
PSD06	PSC45	80	Yellow/Green	1.32	1.87	2.29	2.64	2.96	3.24	3.74	4.18
PSD07	PSC45	85	Green/Green	1.55	2.19	2.68	3.09	3.46	3.79	4.38	4.89
PSD08	PSC45	90	White/Green	1.92	2.71	3.32	3.83	4.29	4.70	5.42	6.06
PSD10	PSC45	95	LimeGreen/Green	2.54	3.59	4.40	5.08	5.68	6.22	7.19	8.03
PSD12	PSC45	100	RoyalBlue/Green	3.10	4.38	5.37	6.20	6.93	7.59	8.77	9.80

Features	
Common Use	Plant Health
Pattern	Hollow Cone
Technology	Swirl
Material	Polyacetal
Spray Angle	45° to 100°
Pressure Range	2.0 - 10.3 Bar (30-150 PSI)
Configuration	Tip

Application Selection Guide	
Foliar Contact	Very Good
Foliar Systemic	Good
Soil Applied	-
Drift Control	-

Part Numbers	
Discs	Cores
PSD01	PSC13
PSD015	PSC23
PSD02	PSC25
PSD03	PSC45
PSD04	-
PSD05	-
PSD06	-
PSD07	-
PSD08	-
PSD10	-
PSD12	-

Secondary Nozzles

EVEN SPRAY (ES) 80°

Recommended nozzles to be used with See & Spray™ in Australian conditions



Targets weeds native to Australia

John Deere See & Spray technology has the ability to direct single or multiple nozzles to spray as required. By directing a single nozzle to spray with a traditional 110° fan nozzle tip, native weeds such as fleabane (which resembles a thin straw) are only covered on one side of the weed. Due to ineffective coverage, full eradication is severely impacted, which encourages future chemical resistance.

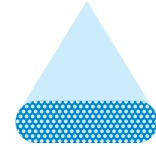

Even coverage is key to killing these weeds

John Deere Even Spray 80° nozzles are designed specifically for single tip applications and are recommended for use with See & Spray technology. The even spray pattern of each ES nozzle provides ultimate knockdown performance across the entire boom in tough Australian conditions.

How do ES nozzles differ from traditional nozzles?

By using a traditional tapered flat fan nozzle, a tapered flat fan spray pattern is produced, impacting weed knockdown effectiveness in certain applications. ES nozzles provide a direct, single application rate and pattern, to reduce overlap and improve chemical effectiveness.

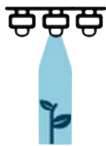

Single (ES)



vs Tapered Double Overlap

Excellent choice for banding and directed post applications

John Deere ES nozzles with their even spray pattern should be used when treating bands.

Even Spray (ES) 80° spray angle - ASABE droplet size classification chart				
Tip Size		03	05	06
Tip Number		PSES8003	PSES8005	PSES8006
Cap Number		PS90003	PS90005	PS90006
Pressure (Bar)	Pressure (PSI)			
2.0	30	C	C	C
2.8	40	M	C	C
3.4	50	M	C	C
4.1	60	M	C	C

Droplet data sourced at Pentair Hypro in a steady state condition per ASABE S572.3 Standard.

Features	
Common Use	Weeds
Pattern	Even Flat Fan
Technology	Elliptical Orifice
Material	Polyacetal
Spray Angle	80°
Pressure Range	2.0 - 4.1 Bar (30-60 PSI)
Configuration	Tip

ExactApply™ Compatibility	
15Hz PWM	Yes
30Hz PWM	Yes
AutoSelect A/B	Yes
Conventional	Yes

Application Selection Guide	
Foliar Contact	Very Good
Foliar Systemic	Very Good
Soil Applied	Very Good
Drift Control	Fair

Service Parts	
Cap Gasket (EPDM)	PM200040-1
Cap Gasket (Viton)	PM200040V1

Secondary Nozzles

BOOMLESS FLAT FAN NOZZLES – FENCE ROW/BOOMLESS (XT)



The XT introduces boomless spray technology, enabling spray to be targeted into places that conventional booms and other tips cannot reach. XT delivers a uniform spray pattern over a distance of up to 16 feet. Ideal for weed control in forests and pastureland.

- Ideal for applications where a conventional boom cannot be used due to obstacles
- Common uses include orchard, vineyard, forestry, pasture, turf and golf course spraying, as well as maintaining rights-of-way and fence rows
- Excellent low-drift option while extending spray reach
- Large droplet size reduces spray drift and promotes spray penetration
- Maintains a consistent spray swath over a pressure range of 2 - 4.1 Bar (30-60 PSI)
- Standard models with precision-molded polyacetal tip and threaded stainless steel body provide excellent durability and low maintenance

Nozzle Size	Pressure (BAR)	Flow Rate (LPM)	Application Rate (l/ha) at KMH								Swath (m) at 2.76 BAR
			4	5	6	8	10	12	15	20	1.22 m High
10 (1/4 inch)	2	3.2	123.1	98.5	82.1	61.5	49.2	41.0	32.8	24.6	3.9
	3	3.9	150.0	120.0	100.0	75.0	60.0	50.0	40.0	30.0	
	4	4.6	176.9	141.5	117.9	88.5	70.8	59.0	47.2	35.4	
20 (1/4 inch)	2	6.4	246.2	196.9	164.1	123.1	98.5	82.1	65.6	49.2	4.8
	3	7.9	303.8	243.1	202.6	151.9	121.5	101.3	81.0	60.8	
24 (1/4 inch)	2	7.7	296.2	236.9	197.4	148.1	118.5	98.7	79.0	59.2	4.9
	3	9.5	365.4	292.3	243.6	182.7	146.2	121.8	97.4	73.1	
43 (3/8 inch)	2	13.9	534.6	427.7	356.4	267.3	213.8	178.2	142.6	106.9	4.4
	3	17.0	653.8	523.1	435.9	326.9	261.5	217.9	174.4	130.8	
	4	19.6	753.8	603.1	502.6	376.9	301.5	251.3	201.0	150.8	

Features	
Common Use	Weeds
Pattern	Boomless Fan
Technology	Pre-Orifice
Material	Stainless or Polyacetal
Spray Angle	105°
Pressure Range	2.0 - 4.1 Bar (30-60 PSI)
Configuration	MNPT & FastCap

Application Selection Guide	
Foliar Contact	Fair
Foliar Systemic	Very Good
Soil Applied	Very Good
Drift Control	Very Good

Part Numbers	
MNPT	Quick Change Polyacetal
PSXTIQ10	-
PSXTIQ20	PSXTQ20
PSXTIQ24	PSXTQ24
-	PSXTQ43
Part Kits for MNPT Version	
PSXTIQ10KIT	-
PSXTIQ20KIT	-
PSXTIQ24KIT	-

Typical Spray Pattern Produced by XT Series

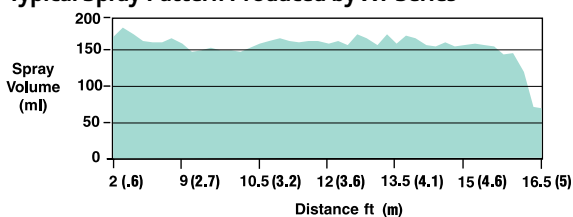

Adjustable Swath Width

Swath width can be increased or decreased by adjusting the angle of the tip +/- 18°.

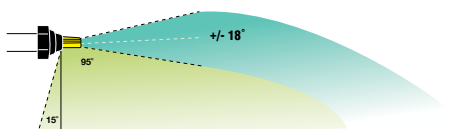

Common Uses of the Boom X Tender Spray Nozzles

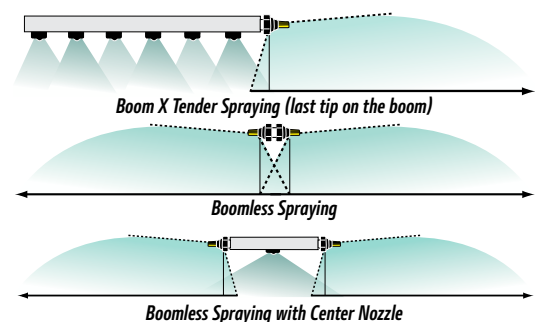

Caps, Adapters and Nozzle Bodies

TWINCAP™ (TC)

The TwinCap™ is a simple, compact way of accommodating two spray tips back to back. This design allows you to apply the volume per acre you want, at the speed you want, without compromising spray quality.

- Improve control of plant diseases, insects, and difficult weeds
- Twin 30° angles improve canopy penetration
- Combined forward and backward angles enhance coverage on stems and leaves
- Holds any two standard dimension tips, including ULA, LD, LDC, ER, ERI, Flat, and Even tips*

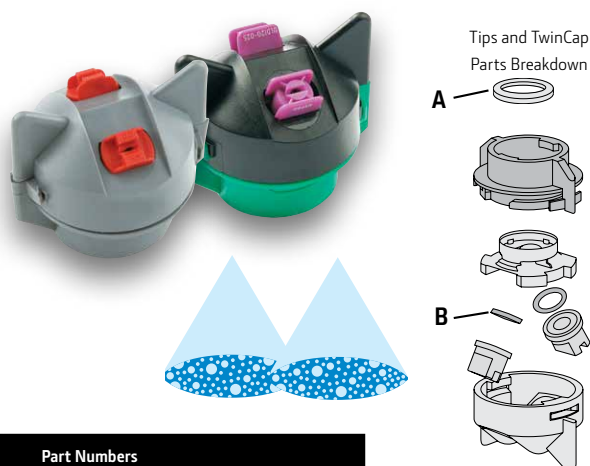

Part Numbers	
TwinCaps, Less Tips	
PSTC	Standard cap for agrochemicals

Part Numbers	
Replacement Parts	
PM200040-1	Standard cap seal (A)
PM200040V1	Viton cap seal for Acid (A)
PM65MN01113	Standard tip o-ring seal (B)

SPRAY NOZZLE CAPS

John Deere caps provide trouble-free spray tip installation and sealing on nozzle bodies and several other common makes.

- Colour-coded to ISO standards for nozzle flow to simplify tip selection and identification in the field
- Available in configurations optimised to fit a variety of spray tip geometries
- Caps for fan pattern tips automatically align tips for enhanced spray uniformity



	ISO Standard Fan	Standard Round (Non-aligning)	Shut-off	Threaded	Push to Connect	Push to Connect	
Fits:	ULD*, LDC, LDA, LD, ER, ERI, OC, FF, ES, ERC	FL	Blank	ST 1/4" MNPT	1/4" w/ gasket	3/8" w/ gasket	Std. Pack
Black	PS90020	PS90420	PS90920	-	PM4200060	PM4200061	10
Orange	PS90001	PS90401	-	-	-	-	10
Green	PS900015	PS904015	-	-	-	-	10
Yellow	PS90002	PS90402	-	-	-	-	10
Lilac	PS900025	PS904025	-	-	-	-	10
Blue	PS90003	PS90403	-	-	-	-	10
Dark Red	PS900035	-	-	-	-	-	10
Red	PS90004	PS90404	-	-	-	-	10
Brown	PS90005	PS90405	-	-	-	-	10
Gray	PS90006	PS90406	-	-	-	-	10
White	PS90008	PS90408	-	-	-	-	10
Included EPDM seal	PM200040-1	PM200040-1	-	PM200040-1	PM200040-1	PM200040-1	40
Included Nitrile seal	-	-	PM65BS205	-	-	-	10
Separate Viton seal	PM200040V1	PM200040V1	-	PM200040V1	-	-	40

*PS17000255 (split gasket EPDM) is recommended for ULD nozzle

Caps, Adapters and Nozzle Bodies

ELBOW AND DOUBLE ADAPTERS FOR SPRAY TIP CAP

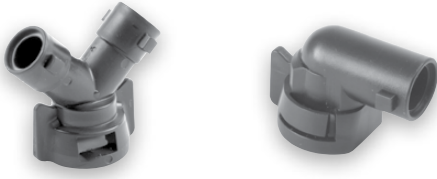

Part Number	Description
PM40291601	45 Double w/ Gasket 6 pack
PM40291401	90 Elbow w/ Gasket 6 pack

HARDI AND JACTO ADAPTERS



Part Number	Adapters For	Description
PM99500024	Hardi*	6 pack of adapters for converting nozzle body to accept John Deere cap
PM99500027	Jacto**	

* Hardi is a registered trademark of Hardi International A/S.

** Jacto is a registered trademark of Jacto Inc.

NOZZLE STRAINERS



- High-quality components and manufacturing ensure reliable spraying in any situation
- Ball check models feature stainless-steel screens and springs, nitrile balls, polyacetal structure
- Premium polypropylene tip strainers feature precise straining with more flow
- Strainers snap on the back of Ultra Low-drift tips for reliable, on-target spraying
- International standard colours denote mesh size

General Strainer Recommendations

Tip Flow Rate at 40 PSI	Strainer Mesh	Example Fan Tip Size
Less than 0.10	200	005-0067
0.10-0.39	100	01-035
0.40-0.79	50	04-06
0.80-2.00	25	08-20



Part Number	Premium Polypropylene Flow Tip Strainer		Premium Flow Polypropylene Guardian™ & GuardianAIR Twin Tip Strainer	
	ISO Colour	Mesh	ISO Colour	Mesh
PS310	Blue	50	PS311	Green
PS0250	Blue	50	PS02100	Green

Caps, Adapters and Nozzle Bodies

NOZZLE BODIES

Nozzle Bodies with the Highest Flow Rates in the Industry

BENEFITS

- Designed to deliver highest flow rates across spraying pressure range
- Unique DCV (diaphragm check valve) design reduces restrictions in the flow path, enabling 9.84 LPM with a .55 Bar pressure drop through the nozzle
- Supports faster field speeds with the same coverage and supports direct fertilizer application through the nozzle body DCV flow path
- Turret-indexing design provides improved consistency and reliability throughout the life of the nozzle body – eliminating free spinning and seizing problems seen on competitive nozzle bodies
- Compact design makes mounting easier with less potential interference with spray boom structure
- Nozzle bodies come standard with an 8 psi (.55 bar) diaphragm check valve. 4 psi, 12 psi, 20 psi, and 25 psi checks are available as options.



FEATURES

- Three turret styles for an easy change of spray tips: single, 3-way, and 5-way
- Provides lowest pressure drop at any given flow in the industry
- 2.6 gpm (9.84 LPM) with a 5 psi (.345 BAR) pressure drop for standard body
- 5.0 gpm (18.92 LPM) with a 5 psi (.345 BAR) pressure drop for high-flow body (AN206621)
- Available in wet or dry boom versions
- Positive shutoff between each spray position

Nozzle Body Performance Curve

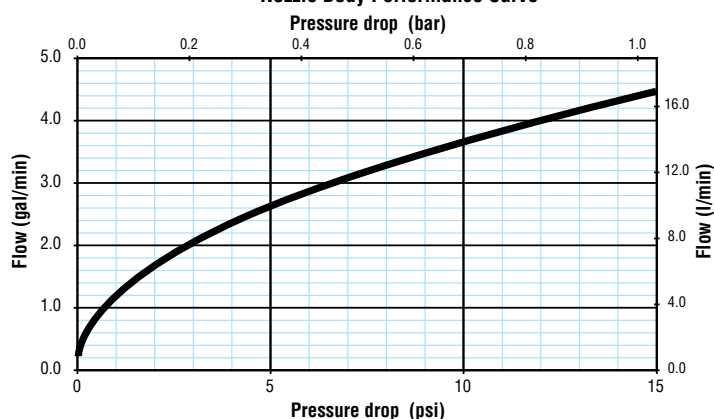

High-flow Nozzle bodies



Part Number	Description
AN206621	Nozzle body, high-flow, 5-position, 11/16-in port, Viton seals
PMHF12DCVV	12-psi check valve with Viton diaphragm (16 open / 12 close)
PMHF15DCVV	15-psi check valve with Viton diaphragm (22 open / 15 close)

Standard Nozzle Bodies, 3- and 5-way for Wet Boom (no tab for boom clamp)



Seal Option/Housing Reference	Turret Options	(to clamp on) Pipe Size	
		3/4"	1"
Viton/Green	3	AN206179	AN305431
	5		AN305432

Single Drop Nozzle Body for Wet Boom



Seal Option/Housing Reference	(to clamp on) Pipe Size		
	1/2"	3/4"	1"
EPDM/Red	PM745	PM755	PM765

Caps, Adapters and Nozzle Bodies

NOZZLE BODIES



3- and 5-way Nozzle Bodies with Tab for Boom Clamp

Seal Option/ Housing Reference	Turret Options	(to clamp on) Pipe Size		
		1/2"	3/4"	1"
EPDM/Red	3	PM42W7	PM42Y7	PM42K7
	5		PM49Y7	PM49K7

Dry Boom Adapters for Wet Boom Nozzle Bodies



Part Number	Type	Clamp Size	Hose Barb
PM6413	Single	1/2" Pipe	1/2"
PM6625	Single	1" Pipe	1"
PM7413	Double	1/2" Pipe	1/2"
PM7519	Double	3/4" Pipe	3/4"
PM7625	Double	1" Pipe	1"

Hose Barb Dry Boom Nozzle Bodies-with DCV



Single Hose Barb P/N	Double Hose Barb P/N	Triple Hose Barb P/N	Hose ID
PM413211	PM413221		3/8"
	PM413222	PM413232	1/2"
PM413213	PM413223		3/4"

Hose Barb Dry Boom Nozzle Bodies-with Top-Mounted DCV



Seal Option/ Housing Reference	Single Hose Barb P/N	Double Hose Barb P/N	Hose ID
EPDM/Red	PM413411	PM413421	3/8"
	PM412	PM422	1/2"
	PM413	PM423	3/4"

Threaded Single Nozzle Bodies-with DCV



Seal Options/ Housing Reference	1/4" MNPT x 1/4" FNPT 8 PSI
EPDM/Red	PM402CPV01

Push-to-Connect Nozzle Bodies & Caps

Type	Push-to-Connect (PTC) Nozzle Body Part Numbers		
	DCV	4 PSI	8PSI
	Size	1 Per Bag	1 Per Bag
PTC to Bayonet	1/4"	PM4247NB119	PM4247NB129
	3/8"	-	PM4247NB121
PTC to PTC	1/4"	PM4247NC119	PM4247NC129
	3/8"	PM4247NC111	PM4247NC121

Push-to-Connect (PTC) Cap Part Numbers		
Type	Size	1 pack
Caps	1/4"	PM42000060
	3/8"	PM42000061

Includes gasket



Hose Barb Dry Boom Nozzle Bodies-No DCV



Single Hose Barb P/N	Double Hose Barb P/N	Triple Hose Barb P/N	Hose ID
-	PM121	-	3/8"
PM112	PM122	PM413132	1/2"
	PM123	-	3/4"

Caps, Adapters and Nozzle Bodies

NOZZLE BODY ACCESSORIES

Replacement Check Valve (DCV) includes Flynut, Housing and Spring

Housing Reference	Spring Pressure (PSI)/Plunger Reference Colour			
	4 PSI/Orange	8 PSI/Black	12 PSI/Yellow	25 PSI/Blue
Red	PM4DCVAE	PM8DCVAE	PM12DCVAE	-
Green	-	PM8DCVAV	PM12DCVAV	PM25DCVAV



Red housing indicates for use with EPDM Seals. Green housing indicates for use with Viton Seals.
Note: Diaphragm seals are sold separately.

Replacement Diaphragm Seal Options for check valves

Option	Part Number	Colour Reference
EPDM	PM03610	Black
Viton	PM036V10	Green

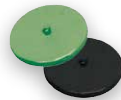

* 8 PSI Diaphragm check valve unless otherwise noted.

Nozzle Body Cap

Standard Pack	Description	Nylon Part Number	Poly Part Number
6	11/16" - 16UN(F) Nozzle cap for tip/barb	PM8027H	PM38027



*Fits all nozzle fittings with 11/16" male straight thread.

Quick Fitting Adapters

Part Number	Description
PM400270N	1/4" MNPT x Quick Attach
PM400275N	1/4" FNPT x Quick Attach

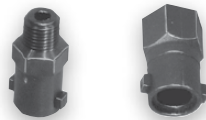

Series 404 Swivel and Threaded-Swivel Nozzle Bodies

Part Number	Description
PM404072N	Single Swivel 1/4" FNPT X Quick Attach
PM404172N	Double Swivel 1/4" FNPT X 2 Quick Attach
PM4174N	Double 1/4" FNPT X 11/16" - 16UN(M)



Vari-Spacing Clamps

Part Number	Ball Thread	Piping/Tubing O.D.
PM1100SS	Steel	1" Square Tubing
PM1125SS	Steel	1-1/4" Square Tubing
PM1150SS	Steel	1-1/2" Square Tubing



* By pipe, dimensions refer to I.D. (inner diameter).

Steel Boom Clamps for use with 11/16" MPS Nozzle Bodies

Part Number	Description
PMBC34R	3/4" Round Pipe
PMBC114	1-1/4" Square



* Dimensions refer to I.D. (inner diameter).

ExactApply™ Nozzle Body Parts Breakdown

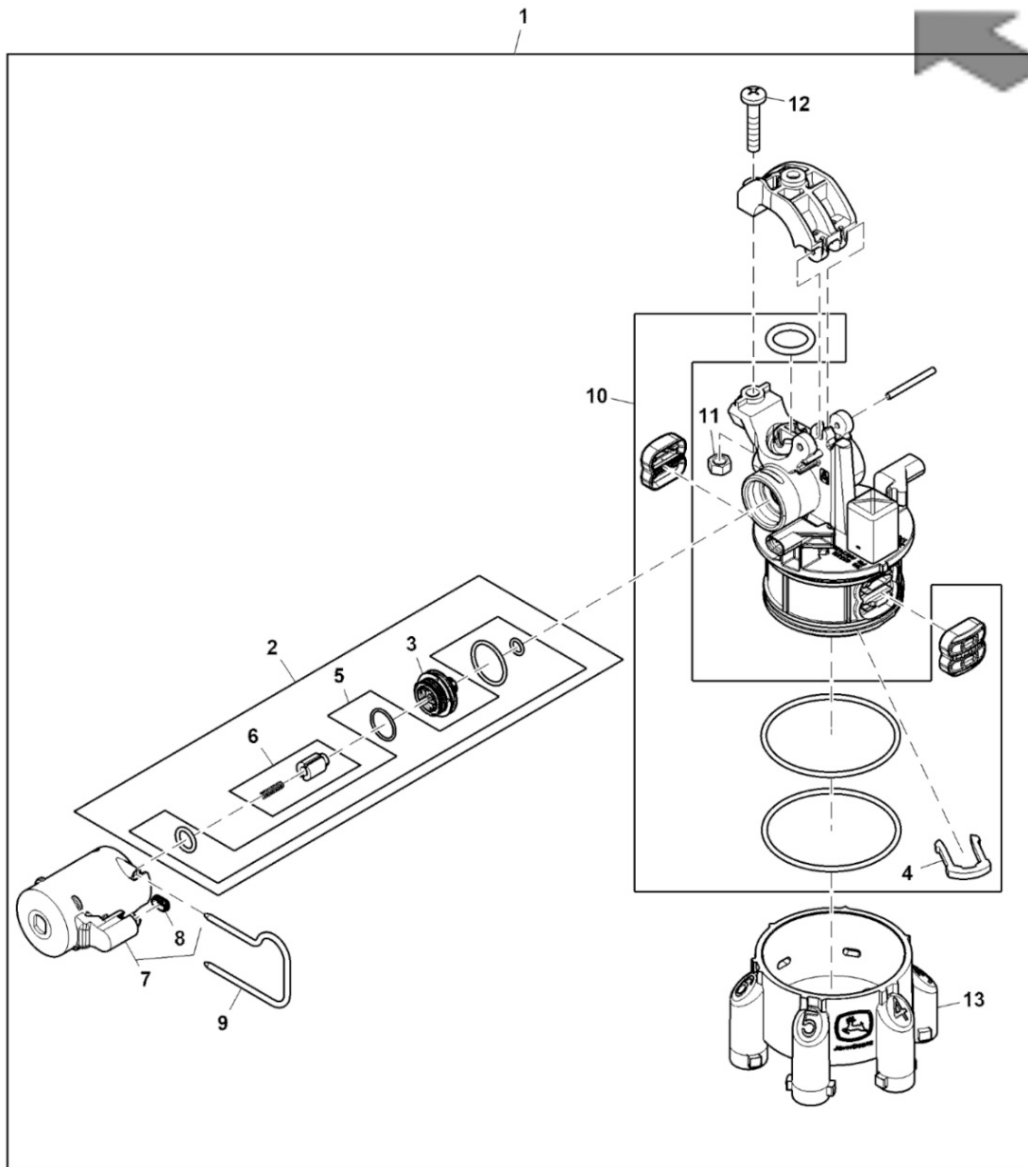

Key	Part Number	Part Name	Qty
1	AKK33737	Nozzle Body Assembly	1
2	AKK39953	Cartridge Valve	2
3	KK49758	Valve Seat	2
4	KK40476	Clip	1
5	AKK28954	Seal Kit for Solenoid Valve	2
6	AKK27643	Solenoid Valve Plunger Kit, Includes Spring	2
7	AKK39954	Electrical Coil	2
8	KK72926	Electrical Connector Seal	2
9	KK25594	Pin	2
10	AKK24868	Nozzle Body Seal Kit	1
11	KK42466	Nut	1
12	21M7666	Screw, M6 x 30	1
13	KK65004	Nozzle, ExactApply Turret	1

Pumps

OEM Sprayer Pumps

John Deere's broad line of centrifugal pumps allows you to match the right pump to your equipment and task. The models include cast iron, stainless steel and polypropylene that stand up to strong chemical herbicides.

- Compatible with corrosive, abrasive and general use chemicals
- Models include high volume (440 gpm) and high pressure (190 psi) capabilities
- Nylon, polypropylene impellers on most models
- Life Guard® silicon carbide mechanical seals standard on all stainless steel pumps and available on select cast iron and polypropylene models



NUMBER	DESCRIPTION	APPLICATION
AN204470	Cast-Iron Pedestal Pump – CW (clockwise) rotation	6100, 6500, 6700
AN204471	Cast-Iron Pedestal Pump – CCW (counter clockwise) rotation	6600, 6700
AN208804	Clutch Driven Cast-Iron Centrifugal Pump – CW (clockwise) rotation	6700
AN208805	Clutch Driven Cast-Iron Centrifugal Pump – CCW (counter clockwise) rotation	6700
AKK36901	Cast-Iron Centrifugal Pump – NPT	4700, 4710
AKK36903	Cast-Iron Centrifugal Pump – NPT	4710, 4720, 4830, 4730
AKK41747	Stainless Steel Centrifugal Pump – NPT	4730, 4830
AKK36900	Cast-Iron Centrifugal Pump – Universal Flange	4920, 4930
AN209114	High-Flow Cast-Iron Centrifugal Pump – Less Motor	4920, 4930
AN400921	High-Flow Cast-Iron Centrifugal Pump w/ speed sensor	4940
AN400923	High-Flow Cast-Iron Centrifugal Pump w/ speed sensor – less motor	4940
AN401863	Cast-Iron Universal Flange Centrifugal Pump w/ speed sensor	4940
AKK36899	Cast-Iron Centrifugal Pump w/ speed sensor	4630, R4023
AKK36894	Cast-Iron Universal Flange Centrifugal Pump w/ speed sensor, metric motor ports	R4030, R4038, R4044, R4045, R4060

ForceField Centrifugal Pump

Superior wet-seal protection for today's most demanding spray conditions.

- Wet-seal technology protects the seals by using a barrier fluid to keep them cool and lubricated, even while the pump is running dry
- Actively maintains a positive pressure differential between the chamber barrier fluid and the pumping solution, which prevents chemical bonding of the seal faces, resulting in increased life and maintenance-free operation
- Protects seal against dry run failure
- Minimizes sprayer downtime and improves productivity

Ask us how the Forcefield pump provides worry-free sprayer operation.

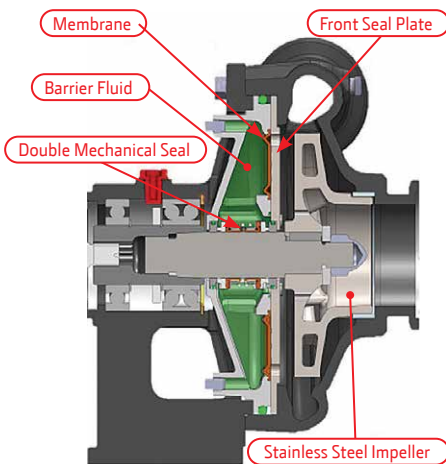

NUMBER	DESCRIPTION	APPLICATION
AKK30367	High-Flow Cast-Iron ForceField Pump	R4038, R4044, R4045, R4060, 410R, 412R, 612R, 616R
AKK30366	High Flow Cast Iron Forcefield Pump, less hydraulic motor	R4038, R4044, R4045, R4060, 410R, 412R, 612R, 616R
AKK39831	Standard Flow ForceField Pump	R4030 – R4060, 408R, 410R, 412R, 616R, 800R



UPGRADES AND ACCESSORIES

John Deere offers a wide variety of upgrades to improve your sprayers performance. From the Express Boom Assembly Kit, End Caps and Flush Valves to Sprayer Calibrators and tip cleanout tools, we offer everything to fit your application needs.

Upgrades & Accessories

EXPRESS BOOM ASSEMBLY Modular Boom Sections

John Deere's Express Boom Assembly provides an economical solution to upgrade your sprayer with 1-in. poly boom plumbing to stainless steel or change nozzle body spacing as desired. Available for John Deere sprayer models 4630, 4710, 4720, 4730, 4830, 4920, 4930, 4940 and R4023.

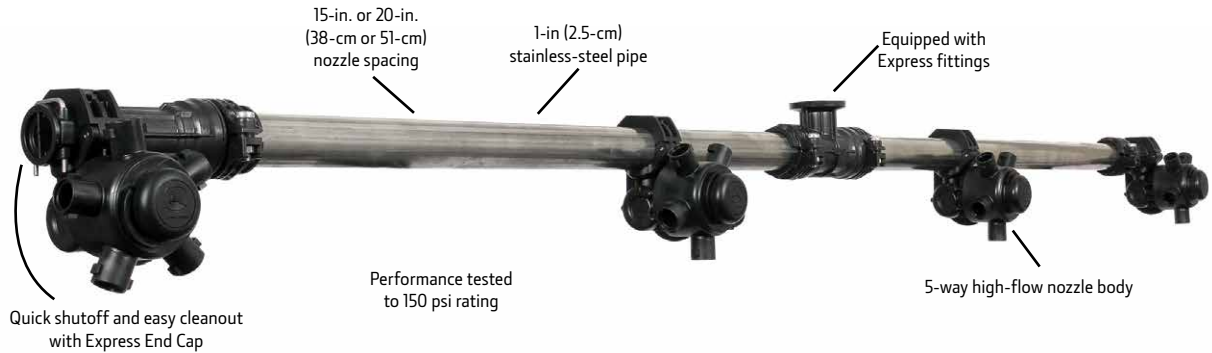

EXPRESS BOOM ASSEMBLY BENEFITS:

- Convert nozzle spacings to 15 in. or 20 in. (38 cm or 51 cm)
- Replace polypropylene plumbing with stainless steel
- Eliminate warping to promote even spray patterns
- Minimize cross contamination
- Simplify cleanout

EXPRESS NOZZLE BODY END CAPS:

- Eliminates trapped air from the boom allowing air to escape through the nozzle body
- Reduces nozzle turnoff time by up to 85%
- Removable plug for easy boom cleanout
- Improves spray boom hygiene reducing the risk of residue buildup
- Fewer field streaks and less overspray

5-WAY HIGH-FLOW NOZZLE BODIES:

- Delivers the highest flow rates
- Supports faster field speeds

The Express Boom Assembly allows you to customize each boom section by choosing the quantity of nozzle bodies either left or right of the tee for each section. Express Boom Assembly has the flexibility to meet any boom design. These single section custom configurations can range from one nozzle body on the left and/or right branch, to six (15" spacings) nozzle bodies on each branch. Review the chart below for all configuration options.

	Choose Left Branch	Tee	Choose Right Branch	
1				1
2				2
3				3
4				4
5				5
6*				6*

* Only available in 15" spacings.

See your local John Deere dealer for all configuration options and ordering assistance.

*not compatible with ExactApply™.

Upgrades & Accessories

EXPRESS NOZZLE BODY END CAPS, FITTINGS AND VALVES



Express Nozzle Body End Cap



Part Number (1 per Bag)	Description	End Cap Plug Kit
PM74333314 = High Flow	1" Express fitting with nozzle body end cap that allows trapped air to escape through the nozzle body	PM74332514
PM74333316 = Standard Flow		PM74332600
PM34300790	Clamp and Hardware Kit with Pipe O-rings for high flow and standard	



Express Nozzle Body End Cap Retrofit Kit



Part Number	Description	Cutting Jig Material
PM34100043 - High Flow	Kit includes machinist-quality drill bit, drilling and cutting jig for 1" pipe, Emery cloth, and instructions to retrofit conventional wet boom spray pipe for Express nozzle body end caps.	Aluminium
PM34100044 - Standard Flow		

Flange Adapters for Express End Caps

Enable the use of Express End Caps on 4 Series Sprayer models R4023, R4030, R4038, R4044, R4045 and R4060.



Part Number	Description	Pkg. qty.
PS24000152	End Cap Flange Adapter - Standard Flow	1
PS24000153	End Cap Flange Adapter - High Flow	1

Note: Flange Adaptors with Express Flush valves are an easy replacement for factory installed air aspirators

Upgrades & Accessories

Express Flush Valve

This valve allows quick flushes of the entire boom section with a turn of a handle. Purchase the Express Flush Valve alone or installed on the Express End Cap.



Features

- Easy-to-use valve does not require any tools to open flushing mode
- Reduces flush time by 55 seconds per valve compared to standard Express End Caps alone.
- Compact valve design limits the length it extends beyond last nozzle body to fit most booms.
- Chemically-resistant, stainless-steel ball and Viton o-rings help extend life

Part Number	Description
PS74333318	Express Flush Valve-High Flow
PS74333320	Express End Cap with Express Flush Valve installed-High Flow
PS74333319	Express Flush Valve-Standard Flow
PS74333321	Express End Cap with Express Flush Valve installed-Standard Flow

Extension Caps

Improve spray efficiency for nozzles that have angled forward/backward inclines. These are also an option for certain boom positions or if lower nozzle positioning is desired.



Part Number	Description	Pkg. qty.
PS91120	Extension Cap with gasket	10

Express Wet Boom Fittings



Part Number (1 per Bag)	Description	Ref #
PM74332502	Express Fitting X 1" Universal Flange Straight	1
PM74332503	2 Express Fitting X 1" Universal Flange Tee	2
PM74332608	Express Fitting X 1" Hose Barb Straight	3
PM74332610	Express Fitting X 1" Hose Barb Elbow	4
PM74332613	Express Fitting X 1" Male Cam Lock Straight	5
PM74332515	2 Express fitting x 1" Universal Flange Tee (Horizontal)	6
PM74332601	Express Fitting X 1" Hose Barb Elbow Horizontal	7

Nozzle Installation Tool

This lightweight tool makes nozzle installation faster with less operator fatigue.

Part Number	Description	Pkg. qty.
PS30000310	Nozzle Installation Tool	1



Upgrades & Accessories

SPRAYER CALIBRATORS

A sprayer's optimal performance, consistency and accuracy relies on precise calibration. John Deere offers several SpotOn® products that help avoid costly over or under application. These tools can quickly identify worn spray nozzles and accurately measure true tip flow rate.



SC-2 Sprayer Calibrator

- Automatically calculates and displays tip flow rate (in gpm, l/min, oz/min), tip wear (in percent), and application rate (in gpa, l/ha)
- Fast and simple operation with readings in about 10 seconds per tip
- Helps quickly identify worn spray nozzle tips (recommend tip replacement once flow rate exceeds that of new tip by 10%)
- Accurately measures true tip flow rate that is essential for calibrating today's high-tech sprayers
- Replaces discontinued SC-1 Sprayer Calibrator (PM23890)

Part Number	Description
PM38790	SpotOn Sprayer Calibrator Model SC-2 (up to 2.25 gpm)

SpotOn is a trademark of Innoquest Inc.

SPRAY NOZZLE CALIBRATION TOOLS



The Spray Tip Calibration Pressure Gauge is attached to a cap and a bayonet to test pressure at the nozzle.

Part Number	Description
PMTESTKIT	Spray Tip Calibration Pressure Gauge

SPRAYER PRESSURE TESTER



Verify accuracy of sprayer's pressure sensor and gauge as well as find blockage in hoses and booms.

Features:

- Digital display reads in PSI, Bars or kPa
- Uses industry-standard quick connects
- One button operation
- Shock-proof rubber covering protects against drops and mishandling.

Specifications:

- Measurement Range: 3.0-160. PSI, 0.20-11.0 Bars, 20-1100 kPa
- Accuracy: +/- 2% or +/- 1 PSI, +/- 0.07 Bars, +/- 7 kPa
- Resolution: 0.5 PSI, 0.05 Bars, 5 kPa
- Battery Life: includes battery with 5-year life
- Note: for test gauge use only, not for continuous use

Part Number	Description
PM28040	Spray Pressure Tester

Upgrades & Accessories

SPRAYER TIP CLEANER AND MULTI-TOOL COMBO PACK

Get both the innovative air blast Nozzle Cleaner and 4-in-1 multi-tool. These tools are designed specifically for sprayer tip and nozzle body cleaning and maintenance.

Features

- Nozzle Cleaner provides a 50 PSI air blast for cleaning debris from spray tips.
- 4-in-1 multi tool features a brush, foldout plastic pick, spanner wrench and utility hook to make tip maintenance quick and easy.

Specifications

- 50 PSI Air blast

Part Number	Description
PM27860	Spray Tip Cleaner and Multi-Tool Combo Pack



SPRAYER TIP TOOL KIT

All the SpotOn tools a sprayer operator needs for finding worn or plugged nozzles, verifying application rate, clean plugged tips and strainers and calibrate your sprayer, all in one compact carry case.

Kit Includes:

- Spray nozzle calibrator
- Air-blast tip cleaner
- Tip multi-tool
- Sprayer output calculator
- Gloves and goggles
- Durable carrying case
- 1-year warranty

Specifications

- Kit Size: 10.5" H x 14" W x 3.5 D (27cm x 36cm x 9cm)
- Kit Weight: 2.6 lbs (1.2kg)
- Range & Units: 0.02 – 1.0 GPM (0.08 – 3.80 L/Min)
- Accuracy: +/- 2.5%
- Batteries: included

Part Number	Description
PM28170	Spray Tip Tool Kit



Upgrades & Accessories

THERMAL INVERSION TESTER



This tool detects low-level thermal inversions and air temperature at boom height as required for pesticide/herbicide applications.

Features

- Display “Inversion Present” or “No Inversion” with intensity shown in degrees based on temperature measurements at heights of 3.3 ft and 9.8 ft
- Measure accurate air temperature at boom height to meet label requirements
- Auto detects when temperature readings are stable
- Backlight on LCD for dawn/dusk or night operation

Part Number	Description
PM35010	Thermal Inversion Tester

WATER-SENSITIVE PAPER



This paper allows users to quickly and easily see spray coverage, droplet size and uniformity, as well as any off-target applications

Features

- Does not warp in humid conditions
- Fully sealed package provides re-closable seal once opened
- Includes tweezers and desiccant packet to improve shelf life

Part Number	Description
PM32920	Water-Sensitive Paper 2" x 3", 25 sheets

MINI-PATTERNATOR



Innovative handheld tool allows visualization of nozzle and sprayer coverage. Most readings are made in less than 10 seconds due to the special channel design

Features

- Quickly visualize spray pattern and coverage
- Easy handheld operation
- Small size for easy transport and storage

Specifications

- Capacity: 16 channels spaced 1 in. apart
- Size: 30cm tall x 45cm wide x 2.5cm thick
- Weight: 1.22 kg
- Construction: PVC Body, Polycarbonate Window, Polyethylene Balls

Part Number	Description
PM26980	Mini Patternator

SPRAYER CALIBRATION

Timely and effective chemical applications have become the leading method to control weeds and insects. Improperly calibrated sprayers can reduce effectiveness and threaten the environment including groundwater contamination or drift. Proper calibration can expose under-pressured systems and worn spray nozzles.



STEP 1. The first step in any calibration effort is to check sprayer/tractor speed. Mark off lengths of 30.48m and 60.96m for measuring sprayer/tractor speeds of 3 km/h and 6 km/h, respectively. Fill the sprayer tank half full of water, select the engine throttle setting and gear that you expect to use when spraying, and then record the seconds required to drive the length of each course twice at their respective settings. Average the results of each set, and use the following equation to determine ground speed. Repeat the test as needed until the correct speed is identified. Mark that setting on the tachometer or speedometer for infield reference.

STEP 2. Record the nozzle spacing, nozzle type, ground speed and product label application rate. Check to ensure all nozzles are of a uniform type.

STEP 3. Multiply the application rate (l/ha) by the speed (km/h) and the width of the spray pattern (w)*. Divide this amount by 600 (a constant) to determine the litres per minute (lpm) produced by each nozzle.

$$\text{Speed} = \frac{\text{Distance (m)} \times 3.6}{\text{Time (sec.)}}$$

$$\text{Flow required per nozzle (lpm)} = \frac{\text{L/ha} \times \text{km/h} \times \text{w}}{600}$$

STEP 4. To set correct pressure, operate the water filled sprayer in place to check for leaks and stoppages. Stop the sprayer, and replace one tip on the boom with an identical new tip and strainer. Check the tip product information sheet for recommended delivery rate and pressure that matches the gpm level calculated in Step 3.

Engage the sprayer and adjust for recommended pressure. Collect the volume of spray produced from the new nozzle tip over a one minute period. Measure the water, and fine tune the pressure setting until the calculated delivery rate is reached.

STEP 5. Repeat the collection procedure with several tips on each boom section. If variations in flow in excess of 10% are produced from more than one tip, replace all old tips and screens.

*If calibrating a sprayer for broadcast application, use nozzle spacing for spray pattern width. If calibrating for banding, use only actual spray pattern in inches (12 bands of 10" each on 30" rows equals spray pattern width of 120" on a 30' boom).

Directed applications with multiple nozzles require that the row or band in inches be divided by the number of nozzles directed at the row to calculate width.

$$\text{Width of Spray Pattern in Directed Applications} = \frac{\text{Band Width}}{\text{\# of Nozzles per Band}}$$

Technical Information

SPRAYING SOLUTIONS OTHER THAN WATER

Liquids that are more dense than water will flow through a spray tip more slowly than water. Solutions that are less dense than water will flow through a spray tip more quickly than water. Unless otherwise indicated, the performance tables in the spray tip section of this catalog show flow and application rates for water-based sprays. To use those tables when selecting tips to apply non-water sprays you must calculate an intermediate "look-up" application rate. To do this you will multiply your actual desired application rate by a conversion factor and then use the resulting "look-up" figure to select a tip from the water-based performance tables. The conversion factors listed on this page are based on typical values for common fertilizer solutions. For other spray solutions, you can calculate the conversion factor by taking the square root of the solution's specific gravity.

Metric

Density (kg/L)	Material	Conversion Factor
0.80		0.89
0.90		0.95
1.00	water	1.00
1.10		1.05
1.20		1.10
1.24	4-10-10	1.11
1.28	28-0-0	1.13
1.30		1.14
1.32	32-0-0	1.15
1.34	7-21-7	1.16
1.40	10-34-0	1.18
1.50		1.22

Example:

Your desired application rate of 28% Nitrogen fertilizer (28-0-0) is 300 L/ha.

Multiply 300 L/ha X Conversion Factor 1.13 to find the converted look-up application rate of 339 L/ha.

Select a spray tip that will apply 339 L/ha of water-based spray. A spray tip that will apply 339 L/ha of water will apply 300 L/ha of 28-0-0 fertilizer solution.

BROADCAST APPLICATION FORMULAS

Application Formulas – Metric

LPM – Litres per minute (per spray tip)

L/ha – Litres per hectare

Kmph – Kilometres per hour

- W
- Tip spacing (m) for broadcast spraying
 - Spray width (m) for single-tip band spraying or boomless spraying
 - Row spacing (m) divided by the number of tips per row for directed spraying

$$\text{LPM} = \frac{\text{L/ha} \times \text{Kmph} \times \text{W}}{600}$$

$$\text{L/ha} = \frac{600 \times \text{LPM}}{\text{Kmph} \times \text{W}}$$

Technical Information

WEAR AND CHEMICAL COMPATIBILITY

Ceramic – Highly resistant to abrasive and corrosive chemistry and provides superior wear resistance in abrasive applications and high pressures. Albus nozzle orifices are made of pink inserted ceramic, reinforced by special oxides, and specially designed by Saint-Gobain for spraying applications.

Polyacetal – Provides good resistance to most chemicals and superior wear resistance to most agricultural chemistry. Susceptible to strong mineral acids and a few organic solvents. Resistance to most alkalis is excellent. Organic solvents usually cause slight swelling without any other harmful effect.*

Polyvinylidene Fluoride (PVDF) – Should be used with acid-based agricultural defoliation chemistry. Good resistance to wear.* Resists many reagents and high temperatures (up to 300°F). Susceptible to high temperatures above water boiling (210°F) in combination with concentrated sulfuric and nitric acids. Preferred in industrial spraying applications.

Stainless Steel – Good resistance to chemicals and provides average wear resistance.

Brass – Average resistance to most chemistry and poor wear resistance. Susceptible to corrosion, especially with fertilizers.

Comparative Accelerated Wear Test

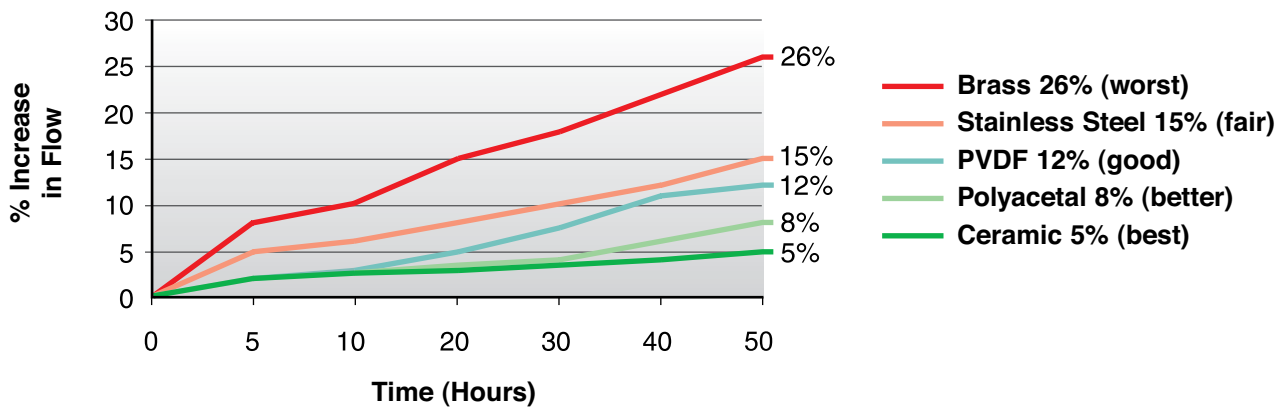

Source: SGS UK LTD. Saint-Gobain AC France
Test Medium: 2.5% Kaolin in water
Test Pressure: 40 psi



This literature has been compiled for worldwide circulation. While general information, pictures and descriptions are provided, some illustrations and text may include finance, credit, insurance, product options and accessories NOT AVAILABLE in all countries or regions. In some countries, products and accessories may require modifications or additions to ensure compliance with the local regulations of those countries. PLEASE CONTACT YOUR LOCAL DEALER FOR DETAILS. John Deere reserves the right to change specification and design of all products described in this literature without notice. John Deere's green and yellow colour scheme, the leaping deer symbol, and JOHN DEERE are trademarks of Deere & Company. All photography and illustrations contained herein are copyrighted assets of Deere & Company.



JOHN DEERE

JohnDeere.com.au
JohnDeere.co.nz